



# Ventura 150/200T Connect

## Installation and Operating Manual



Spectra Watermakers  
Katadyn Desalination LLC.  
2220 S. McDowell Blvd Ext. Petaluma, CA 94954  
Phone: 415-526-2780 Fax: 415-526-2787  
info@spectrawatermakers.com  
www.spectrawatermakers.com  
Updated January 2024



# Spectra Connect Quick Start Guide

When you first power up the system, you will get a warning message, asking **if the system has been stored with chemicals**.

If the system has been pickled, winterized, this is the first startup, or the condition of the system is unknown, **go to New System Start-Up and Testing on page 28** or serious damage may occur.

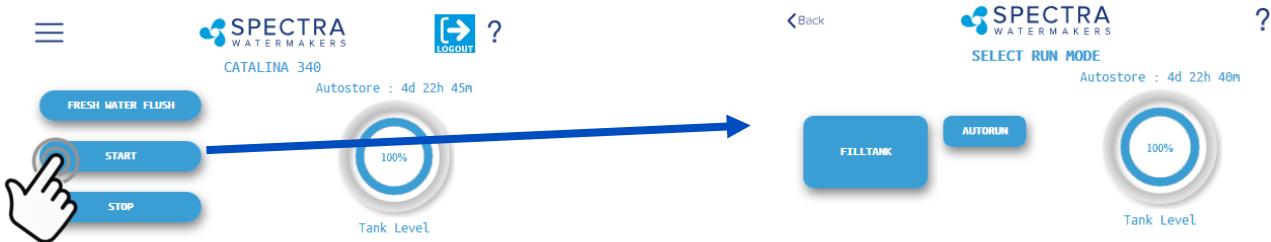

## Start

Pressing the 'Start' button once advances to the Run Mode selection screen.

## Run Mode

Select your desired Run Mode to start making water and filling your tanks. See details on Run Mode options on p. 37



## Fresh Water Flush

Pressing the 'Fresh Water Flush' button flushes the watermaker with fresh water from the vessel's domestic water tanks. After completing the flush, Spectra Connect will automatically enter the Auto Store mode.



## Stop

Pressing the 'Stop' button from the Home Screen will end the Auto Store mode countdown timer and leave your watermaker in Standby mode.

## Spectra Connect Modes and Definitions

**Auto Store:** After the watermaker fresh water flushes, it will start a countdown timer that can be seen on the Home screen. The timer indicates the next programmed fresh water flush if the watermaker is not started again, or the 'Stop' button is not pressed.

**Fill Tank:** The watermaker will automatically run until the Tank Full switch in the water storage tanks closes. Once the Tank Full switch closes, the watermaker automatically fresh water flushes, then reverts to the *Auto Store* mode.

**Auto Run:** The watermaker can be set to run for a number of hours, or for a quantity of water to be produced. When the desired quantity of water is produced or the run timer expires, the watermaker will Fresh Water Flush and enter the *Auto Store* mode.





## **EXCITING EXTENDED WARRANTY OFFER!**

*-Upgrade the standard 1-YEAR manufacturer warranty to 2-YEARS and LIFETIME on Clark Pump.*

*Follow the below steps to submit for approval:*

- 1. Have system installed & commissioned by Spectra Authorized FSP (full-service provider)**
- 2. Fill out web-based Product Registration form (see back of owner's manual for paper copy)**
- 3. Complete web-based install/commissioning form (see back of owner's manual for paper copy)**
- 4. Upon satisfactory review of required submissions, your 4-digit system serial number will receive an extra year of warranty coverage, and lifetime coverage on the Clark Pump!**

*See 'Extended Warranty' section of owner's manual for full coverage details.*

### **Spectra Product Registration Form**

**(To be completed by end user/owner)**



[https://spectrawarranty.formstack.com/forms/product\\_registration](https://spectrawarranty.formstack.com/forms/product_registration)

### **Spectra Watermakers Commissioning Report**

**(To be completed by authorized installer)**



[https://spectrawarranty.formstack.com/forms/spectra\\_install\\_commissioning\\_report](https://spectrawarranty.formstack.com/forms/spectra_install_commissioning_report)

*Note: Offer & warranty criteria effective 1/1/2021. For purchases made in the EU, please see 'Expanded Warranty' section of warranty policy in back of the manual for EU specific coverage.*



## **Spectra Watermakers - User Manual Online Access**



- Scan QR Code to Visit Spectra Manuals Page.
- Select System, then download the User Manual.
- Reference Commissioning Checklist for important installation requirements.
- Review Installation Basics section of Owner's Manual to ensure warranty compliance.

<http://katadyngroup.ladesk.com/206595-Spectra-Manuals>

# Table of Contents

<b>Installation</b> .....	
Getting Started.....	8
Installation Basics.....	9
Introduction .....	10
Components.....	11
Ventura Plumbing Schematic.....	13
Product Water Plumbing .....	14
Product Water Manifold –Installation .....	15
Tube Fitting Assembly Procedures.....	16
Spectra High Pressure Fitting Instructions.....	17
Electrical.....	18
Wiring.....	20
Tank Switch Wiring and operation.....	21
Optional Z-Ion .....	23
<b>Operation</b> .....	26
New Systems Start Up and Testing.....	28
Dry Testing with an Artificial Ocean.....	30
Sensor Calibration .....	31
Networking.....	34
Normal Operation .....	38
<b>Maintenance, Storage, and Troubleshooting</b> .....	
Maintenance .....	43
Suggested Spares.....	50
Introduction to Spectra Chemicals .....	45
Long Term Storage Procedures.....	47
Winterizing with Propylene Glycol .....	48
Membrane Cleaning Procedure.....	49
Troubleshooting.....	51
Manual Operation.....	53
Ventura Flow Test .....	54
Poor Water Quality .....	56
Technical Bulletins .....	57
<b>Spectra Settings</b> .....	62
Fault Handling .....	67
Wiring Schematic .....	68
Ventura 150C-200C-T Electrical Specifications.....	69
<b>Exploded Views and Part Numbers</b> .....	72
<b>Owner Resources</b> .....	
Warranty, Product Registration, Installation & Commissioning Reports.....	83

# Installation

## Getting Started

Unpack the system and inspect it for damage during shipping. Freight damage must be reported to the carrier within 24 hours.

Refer to the shipping list for your system to ensure you received all of the components listed. Do not discard any packaging until you have found and identified all of the parts. The small installation parts are listed on the kit list.

***Warning! We will not be held responsible for shortages that are not reported within thirty days of the ship date.***

Study the system layout diagram, component photos, and descriptions before beginning installation.

Lay out the system. Before starting the installation identify where each module and component will be placed. Ensure that there is enough clearance around the components for removal of filters and system service. Make sure you have adequate tubing and hose before starting. Additional parts may be ordered.

*THE VENTURA 200T IS DESIGNED FOR WARM WATER USE. OPERATION IN WATERS BELOW 50° F (10° C) MAY CAUSE HIGH OPERATING PRESSURES AND INCREASED WEAR ON THE FEED PUMP.*

### Ventura 150-200T Connect Shipping List:

- Ventura Connect kit (includes control box and display)
- Accumulator Assembly with analogue gauge
- High pressure Clark Pump with membrane pressure vessel
- Product manifold assembly
- Black high pressure filter housings
- Feed pump assembly with fresh water flush module
- Ventura Connect install kit with black product water tubing
- Service kit
- Two lengths 5/8" Hose (25')

Optional: Z-Ion system

## Installation Basics

- **Read the directions!**
- Avoid tight hose bends and excessive runs.
- Use heavy gauge wire.
- Install feed pump module as low as possible.
- Use a dedicated thru-hull with scoop type strainer.
- Do not mount components over electrical devices.
- **Avoid getting dirt or debris into the piping or hoses during assembly.** A small bit of debris can stop the system!

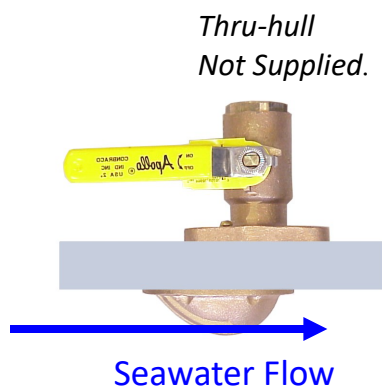

**Thru-hull Location:** The system must be connected to a dedicated 1/2" to 3/4" forward facing scoop-type intake thru-hull and seacock.

Install the thru-hull intake as far below the waterline and as close to centerline as possible to avoid contamination and air entering the system. Do not install the intake close to, or downstream of, a head discharge, behind the keel, stabilizer fins, or other underwater fixtures.

Thru-hulls in the bow area are susceptible to air intake in rough conditions. Sharing a thru-hull can introduce unforeseen problems such as intermittent flow restrictions, air bubbles, contaminants, and will void the warranty. For racing boats and high speed boats traveling above 15 knots, a retractable snorkel-type thru-hull fitting is preferred because it picks up water away from the hull.

**The brine discharge thru-hull** should be mounted above the waterline, along or just above the boot stripe, to minimize water lift and back pressure.

Avoid restrictions or long runs on the entire inlet side of the plumbing from the thru-hull to the feed pump module.

Secure the piping away from moving objects such as engine belts and hatches. Prevent chafe on the tubing as required. Test and inspect all piping and hose clamps after several hours of operation.

**Pipe Fitting Instructions:** To seal plastic-to-plastic fittings, wrap 6 to 8 layers of Teflon tape over their threads. Hold the fitting in your left hand and tightly wrap the threads clockwise. For smoother assembly, do not tape the first (starting) threads.

### Wiring

- Pay attention to wire size or system performance will be impaired
- Perform wiring to UL, ABYC, CE or applicable standards

# Introduction to the Ventura Connect

The Ventura is the finest watermaker for small and mid-sized yachts. Properly installed and maintained it will provide years of reliable service. Prudent operation is required with any marine equipment. ***Always maintain enough reserve water to get safely into your next port.***

The Spectra Intensifier, known as the Clark Pump, was introduced in 1997 and has been continually improved since. It is built of modern non-corrosive composites and comes with a 20" high rejection membrane.

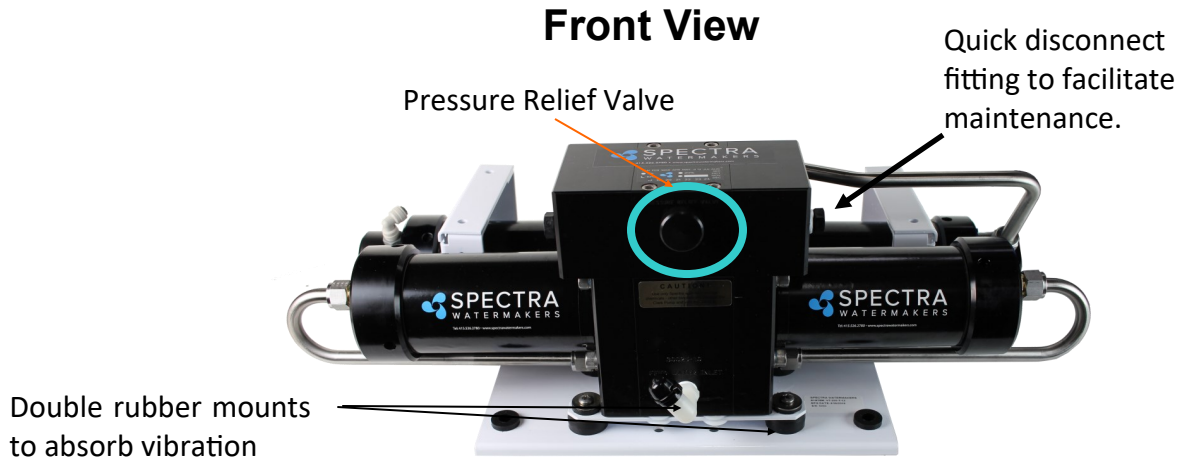

The Clark Pump Membrane Module. Pre-mounted and plumbed together as a single unit. Saves time and adds reliability.



## Ventura Feed Pump Module

Includes the feed pump, cooling fan, charcoal filter, flush valve, service valve, and service port. The module has compact and streamlined plumbing. The cooling fan is included for longevity.

**Note:** If your system came with the optional Z-Ion, the Z-Ion unit will replace the charcoal filter housing. The photo above, and all subsequent photos of the Feed Pump Module, will look slightly different.

# Components

**Sea Strainer** Mount close to the intake through-hull, in a location that can handle water spillage during service.

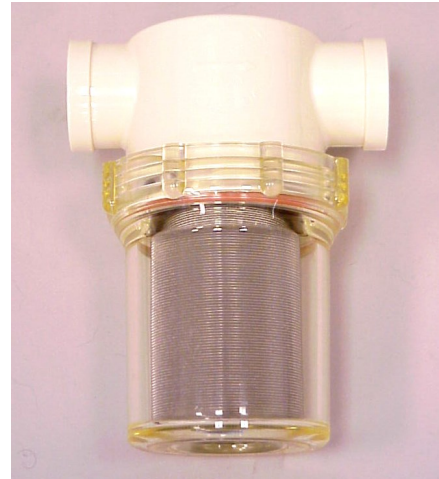

## Feed Pump Module

Mount the feed pump module on a vertical surface, up to 3-feet (1.0M) above the waterline. It is preferable to mount as low as possible. Locate in an area that allows easy access to the charcoal filter, and the service valve. Keep future maintenance in mind when choosing a location, and do not mount above water-sensitive equipment.



**IF INSTALLING THE Z±ION, SEE Z±ION INSTALL INSTRUCTIONS FOR MORE DETAILS.**

**Dual Prefilter Filter Bowls** Locate in an area that allows easy access as these will be the most frequently serviced module while cruising. Mount vertically and leave room below bowls for filter changes. Do not mount above water-sensitive equipment.





## Components - Cont.

### Remote Touchscreen

The remote control panel can be mounted anywhere dry and convenient. Cut a 5-5/8" (12.7 cm) wide by 3-1/4" (7.62 cm) high opening for the panel. The display needs minimum 2 1/2" deep clearance for the cable. Take care not to damage the plugs on the ends of the cable when routing. **Use only a Spectra-approved cable.**



### Clark Pump and Membrane

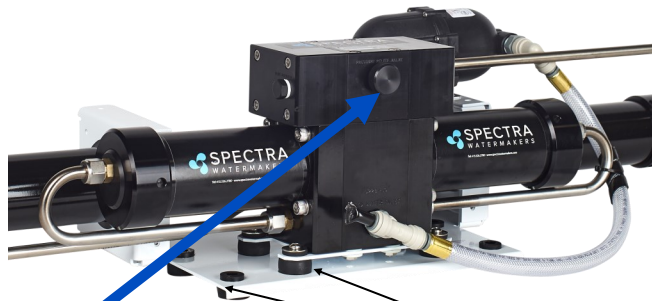

**Pressure Relief Valve**

Double rubber mounts  
to absorb vibration

This module must be installed in an area that maintains a temperature below 113°F (45°C). It may be placed as high in the boat as you desire, and mounted in any position, even upside down. Make sure that the area around and under the pump does not have any water sensitive equipment, as water will be spilled during any repairs or if a leak occurs. Allow for easy access to the pressure relief valve.

The Clark pump and membrane module comes complete with a mounting system. Be sure to use the supplied washers on the rubber feet.



# Ventura Connect Plumbing

Note: Brine discharge may be connected to either side of Clark Pump

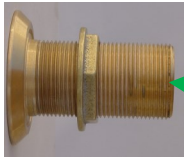

**Brine discharge thru hull (not included):** place above waterline or tee into another visible drain.

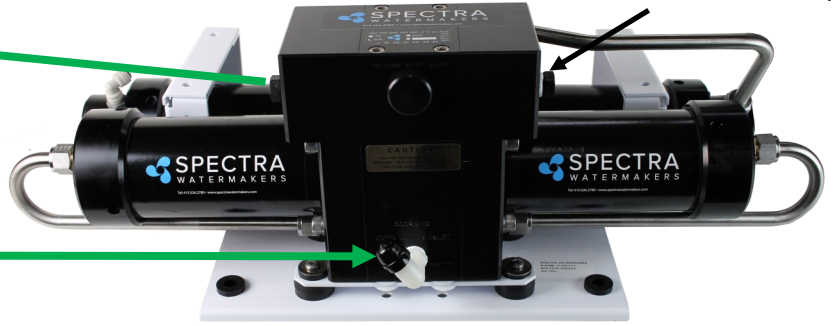

**Spectra Clark Pump and Pressure Vessel/Membrane:** Mount in a cool location (below 120 deg. F/49 deg. C). May be oriented in any position and can be well above waterline. Leave access to the pressure relief valve. Do not mount over electrical equipment. Use supplied spacers and washers for the vibration mounts.



**Connect Control Box:** Remember to mount in central location, where various cables can reach all components and the power supply.



**Accumulator:** Factory pre-charged

**20 and 5 micron filters.** Do not mount over electrical equipment. Leave clearance underneath for filter changes.



**Sea Strainer:** Mount with included Quick Block

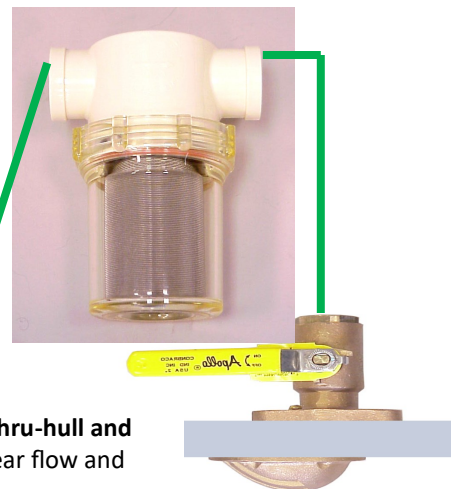

**1/2" or 3/4 scoop strainer thru-hull and Seacock:** Mount low, in a clear flow and away from head discharge.

Use the supplied 5/8-inch (15.9mm) clear braided vinyl hose for all runs. More hose may be ordered from Spectra, or bought at a hardware or marine store.

**Fresh Water Flush inlet to charcoal filter:** Fresh water from ship's pressure water system 30 psi (2bar) minimum. 50 psi (3.5bar) maximum.



**Feed Pump Module:** Mount vertically as low as practical, no more than 3' (1M) above waterline and not over electrical equipment. Leave clearance below for filter changes.

# Product Water Plumbing

The Product Manifold needs to be installed on the high-pressure module and the 1/4"(6mm) product water tubing needs to be plumbed accordingly. See the following page for installation instructions

**Product to tank:** Route the product water into the top of a vented tank, or a tee in the water tank fill hose. **DO NOT** feed into a vent line, manifold, or into the bottom of the tank. Bladder tanks will create too much back pressure. There must be no restriction or back pressure whatsoever in this piping.

When the system is turned on and pressurized the product water will leave the membrane, move through the product flow sensor, over the salinity probe and into the diversion valve. When the Spectra Connect board registers product water below 750 ppm for 60 seconds the diversion valve will open and the water will move from the reject path to the accepted product water output-to tank.

The diversion valve can be manually overridden without the Spectra Connect using the Manual Override Button. Push the button down to manually divert the water to tank. Twist the button 90 degrees to lock the valve in place.



Accepted Product Water Outlet-To Tank

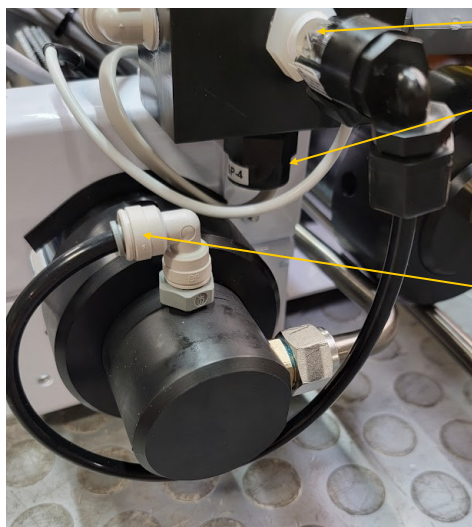

- Product Flow Sensor
- Salinity Probe (SP4)
- Product from membrane

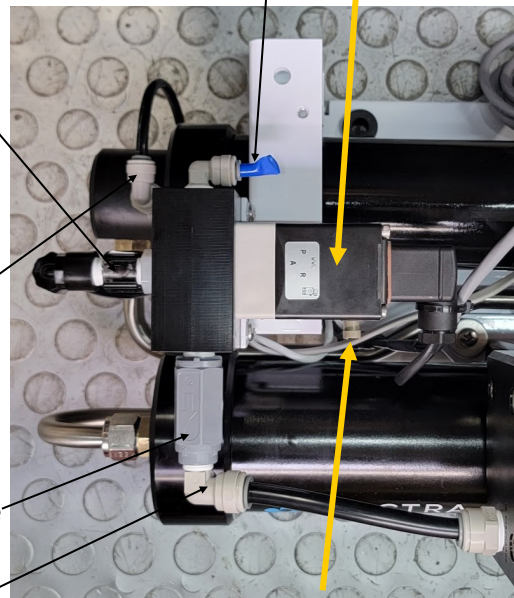

- Check Valve
- Rejected product outlet
- Manual Override Button
- Diversion Valve

## Product Water Manifold-Installation

1

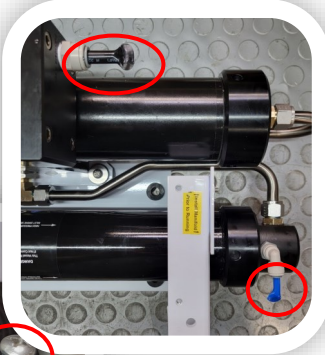
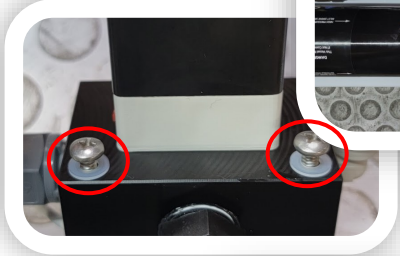

1

- Remove 3/8" tube plug from Brine Discharge Fitting.
- Remove 1/4" tube plug from Product Output elbow fitting on membrane.
- Remove both screws from product manifold (10x24 1/2" pan head with #10 washer.)

2

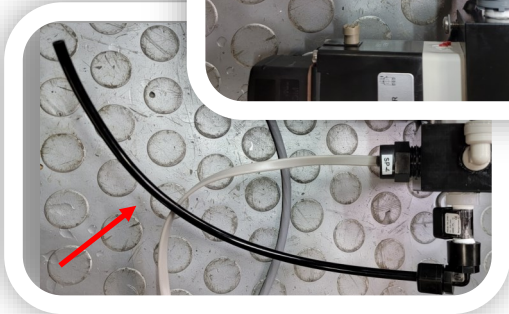

2

- Ensure the black 3/8" tube is installed in the elbow fitting leaving the gray check valve.
- Ensure the black 1/4" tube is connected to the fitting leaving the clear plastic product flow sensor. A secure fit should be established at the factory during testing.

3

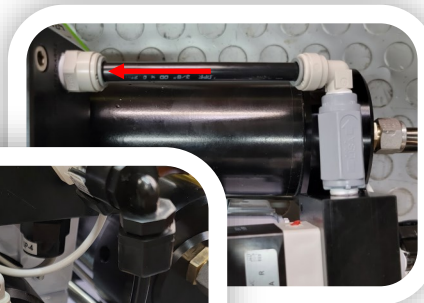

3

- Connect the 3/8" tube to the brine outlet fitting.
- Connect the 1/4" tube to the Product Output elbow fitting on membrane.

*Note: Connection will leak if tube is not bottomed out in fitting.*

4

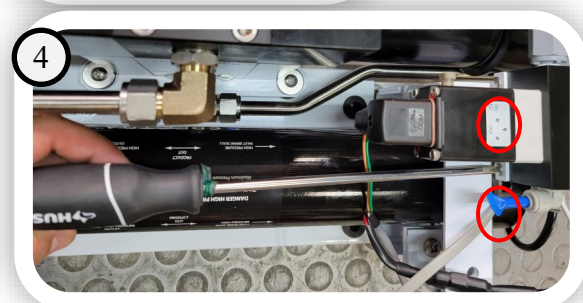

4

- Using the screws and washers provided securely fasten the manifold to the bracket with a P1 screwdriver.

*Pro Tip: A long screw driver will greatly aide in installation*



# Fast & Tite® Thermoplastic Fittings

Fast & Tite® fittings are the most complete line of plastic fittings for thermoplastic tubing in the industry.

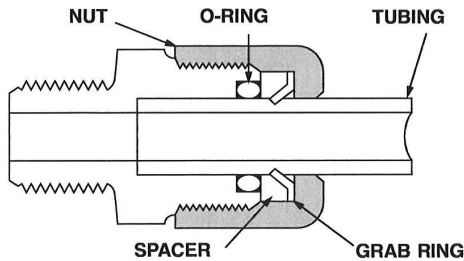

Fast & Tite® thermoplastic tube fittings from Parker will prove to be the answer to your tubing connector needs. Patented Fast & Tite® fittings install in seconds without tools and provide a tight, sure, leak proof seal without clamps or adjustments. A unique 302 stainless steel grab ring for tube retention, coupled with a Nitrile O-Ring for positive seal, assures good tube connection with only hand tight assembly. A plastic grab ring is also available upon special request. Vibration or tube movement will not break the seal and cause leakage. Preassembled in either highly inert polypropylene, or strong, durable nylon, Fast & Tite® fittings are the answer to full flow thermoplastic tubing system requirements.

When necessary, Fast & Tite® fittings can be disassembled by hand for fast system drainage. Fittings are completely reusable.

Parts are easily replaced. O-Rings are standard size and universally available. (For applications requiring other than Nitrile O-Rings, consult your Fast & Tite® distributor.)

Use Fast & Tite® fittings with Parker Parflex tubing or other plastic, glass or metal tubing for low pressure or vacuum lines up to the pressure limits shown below.

Fast & Tite® fittings meet FDA and NSF-51 requirements for food contact.

## Working Pressures for Fast & Tite® Fittings

Tube O. D., in.	Air-Oil-Water Pressure in PSI		
	Up to 75°F	76° to 125°F	126° to 175°F
1/4	300	300	300
5/16	300	300	300
3/8	250	250	150
1/2	200	200	150
5/8	150	100	50

Ratings are based on use with copper tubing, and in all cases represent the maximum recommended working pressure of the fitting only. Working pressures (vs. temperatures) of other types of tubing may limit the tube and fitting assembly to pressures lower than shown above. Consult factory for recommendations on applications other than shown above.

## Temperature Range:

Black/White Polypropylene: 0°F (-18°C) to +212°F (+100°C)  
 White Nylon: -40°F (-40°C) to +200°F (+93°C)

## Fast Assembly

### Step 1.

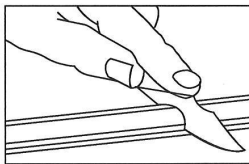

Cut the tube squarely and remove any burrs.

### Step 2.

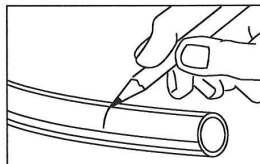

Mark from end of tube the length of insertion. (See table below)

Tube O.D. (in.)	Insertion Length with Tube Support (in.)	Insertion Length without Tube Support (in.)
1/4	5/8	9/16
5/16	5/8	9/16
3/8	13/16	3/4
1/2	7/8	13/16
5/8	1	15/16

### Step 3.

Loosen nut on fitting until three threads are visible. Fittings for glass tubes must be disassembled and the grab ring removed.

### Step 4.

Moisten end of the tube with water. Push the tube **Straight** into fitting until it bottoms on the fitting's shoulder. Tighten nut by hand. Additional tightening should not be necessary, but 1/4 additional turn may be added if desired. **Do not overtighten** nut as the threads will strip and the fitting will not function properly. A proper assembly will not show the insertion mark extending beyond the nut. If the insertion mark is visible, then steps 1 thru 4 must be repeated.

### Step 5.

When using clear vinyl tubing or urethane tubing, it is necessary to use a **TS** tube support. Disassemble the fitting and place the nut, grab ring, spacer and tube support, in that order on the tube. Locate the grab ring at the insertion mark as shown. Seat the O-ring in the body, then proceed with Step 4.

**Note:** Provide adequate fail-safe mechanisms such as leakage detection sensors, automatic shut-off controls or other industry and code appropriate fail-safe devices in the design of your water-handling appliance to protect against personal injury and property damage.

Plastic fittings containing an o-ring that are used in water applications should be replaced at least every five years or more frequently depending on the environment and severity of the application.

# Spectra High Pressure Fitting Instructions

The Ventura has eight high pressure fittings, two on each cylinder on the Clark Pump, two on the pressure vessel end caps, and two 90-degree elbows on the back of the Clark Pump. As the compression fitting is tightened, it compresses a ferrule onto the stainless tubing, fixing the ferrule permanently to the tube and holding the compression nut captive.

The body of the fitting seals to the underlying component with an O-ring. On the Clark Pump cylinders and the end caps this O-ring is compressed by tightening the entire fitting. The O-rings on the 90-degree fittings on the back of the Clark Pump have captive nuts and washers, which compress the O-rings without turning the entire fitting.

If a tube fitting leaks it can sometimes be resealed by just tightening. You must use two wrenches, a 13/16-inch wrench to hold the base, and a 7/8-inch wrench to turn the compression nut. The 13/16-inch wrench will need to be thin so as not to interfere with the compression nut. If this doesn't work, disassemble the fitting, grease liberally with silicone grease (the ferrule and the threads) and re-tighten firmly.

The base O-rings should be **gently** compressed to achieve a good seal, and may be damaged by overtightening.

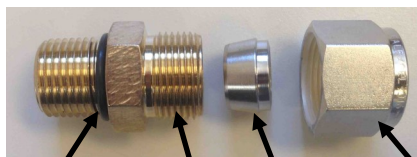

Connector O-RING

Ferrule

Stainless Fitting Hex Nut

Nickel-Bronze High Pressure Straight Fitting



Nickel-Bronze High Pressure Elbow

# Electrical

Ventura Connect systems are pre-fitted with waterproof connectors for electrical and signal cables. Each connector is different, so it is impossible to connect them incorrectly, and the connectors are color-coded. The system has a power inlet harness with a terminal block and cover, Pump power cable, pressure transducer red and green cables, a 5-conductor diversion valve and product flow sensor cable, a 2-conductor fresh water flush solenoid cable, a Z-Ion power and signal cable, and a 50-foot (15M) cable for the Connect display.

**Do not install it in hot or poorly ventilated locations.**

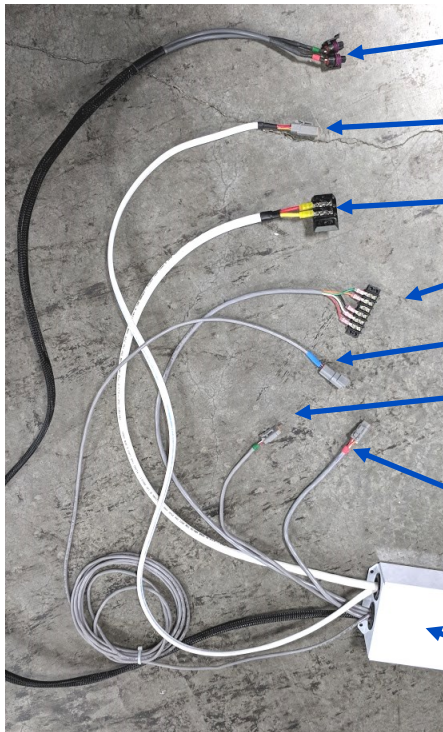

Pressure transducer cable. Connect to like red/green sensors atop filter bowl

Feed Pump Power Cable

Power inlet harness with terminal block

Tank Monitoring Terminal Block

Standard Fresh Water Flush connector (Blue)

Z-ION Connector (with green band). Left unused if your system was not ordered with the optional Z-ION.

Product manifold assembly (Red-connects left of Clark Pump)

Tank Full Switch  
Green + Orange  
Tank Level Sensor  
5vdc: Red  
Signal: White  
Ground: Black

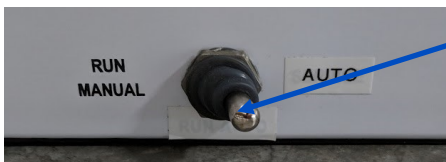

Run Auto/Manual/Service toggle switch

Spectra Connect Circuit Board (Inside control box)

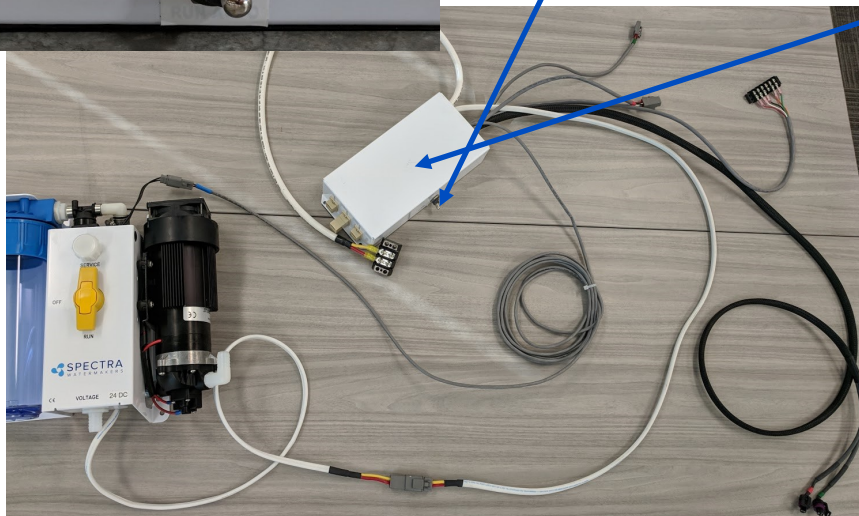

## Electrical - Cont.

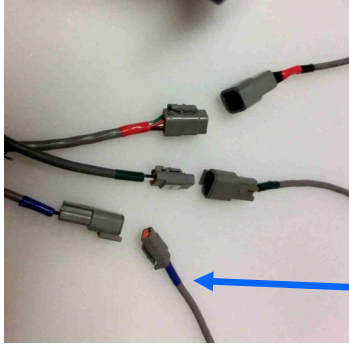

Diversion Valve and Product Flow Sensor Cable (5-conductor, Red).

Z-Ion power and signal cable (3-conductor, Green)

Fresh water flush solenoid cable (2-conductor, Blue)

The Ventura Connect has three external ports; one for the display, one for networking, and one for the salinity probe. The Salinity probe is a 5 pin cable with RJ-12 connectors (phone jack) on both ends this cable runs in parallel. The Display cable is a standard Cat 5e ethernet cable.



Mount the main power terminal block in a junction box or on a bulkhead adjacent to the feed pump module. Make sure that this is a dry location well above bilge level and not subject to water spray. **Be sure to install the terminal block cover.**

Check the wire size chart for appropriate wire sizes. DC power feeds should be uninterrupted to insure proper operation of the auto store feature. Avoid house breaker panels that could be accidentally tripped.

### Wire Size Guide for the Ventura 12V:

#### Protect with 15 Amp Fuse or Circuit Breaker

10 Gauge (5mm<sup>2</sup>) up to 15 feet (4.5M)

8 Gauge (8mm<sup>2</sup>) up to 25 feet (7.5M)

6 Gauge (13mm<sup>2</sup>) up to 35 feet (10.6M)

### Wire Size Guide for the Ventura 24V:

#### Protect with 7 Amp Fuse or Circuit Breaker

10 Gauge (5mm<sup>2</sup>) up to 25 feet (7.6M)

8 Gauge (8mm<sup>2</sup>) up to 35 feet (10.6M)

**Distances at left represent the total ROUND TRIP wire length (DC positive length plus DC negative length), NOT the length of the pair of wires together. Size cables accordingly.**

**Note: If the specified circuit breaker sizes are unavailable, use the next higher rating but do not exceed the specification by more than 10%. All wiring to be done to applicable ABYC, Marine UL, or CE standards.**



# Wiring

Mount the control box with 4 appropriate fasteners on a vertical surface, above components containing water, with the wire grommets down, and central to the other system components. Make sure the cables will reach all of the modules to avoid splices. The main power feed should come from an appropriately-sized fuse or breaker on the main DC panel. See wire size and fuse/breaker tables below.

**Warning! Do not connect the main power feed until all other connections are made.**

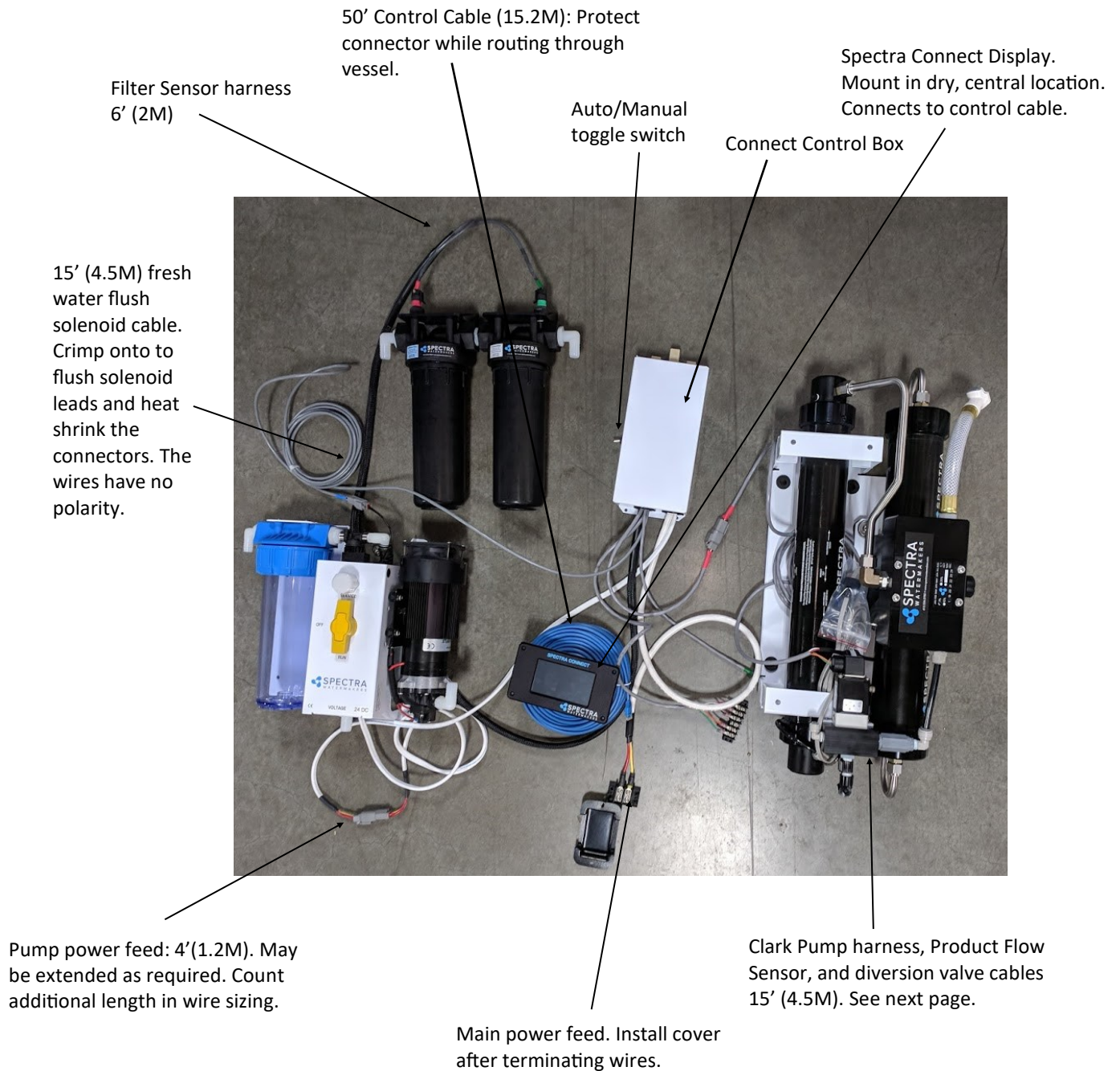



# Tank Switch Installation

## Factory Supplied Tank Full Switch

Installing the supplied tank full float switch at the top of your water tank allows the Spectra Connect to fill your water tank then automatically stop, fresh water flush and return to Auto Store mode with no additional user commands.



Drill and tap a 1/8" npt port into the top of the fresh water tank that is being filled by the watermaker. This can be installed on a tank access cover, or directly into the water tank. If installing on an access cover, be sure to leave a service loop on the float switch wiring to allow removal of the tank access cover.

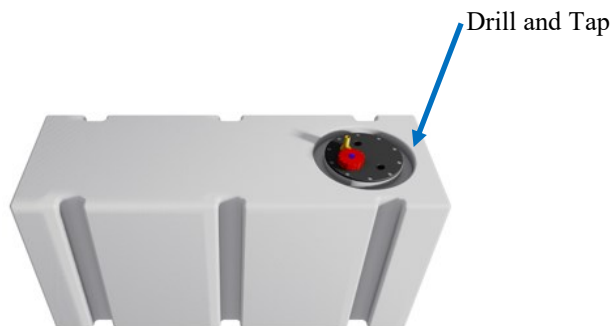

The supplied float switch must be connected to the **Green and Orange** conductors at the Feed Pump Module, labeled **Tank Full Switch**. There is no polarity. Connect to Tank 1 terminals.

**Use 18/2 tinned wire or larger. Wire is not included in the installation kit.**



Connect to Gr/Or wires



For Instructions on 'Auto Fill' mode and installing a Tank Low switch, see 'Auto Fill' mode instructions later in this manual.

**Watermakers should never be run unattended.**

Your watermaker comes with the top-mounted Tank Full Switch (EL-SWT-LV) and is designed to be mounted to the top of the water tank. The side-mounted float switch (EL-SWT-SMLV) can be sourced from your local dealer or Full Service Provider if you cannot access the top of your tank.

***If you do not install the Tank Full switch in your tank, you MUST DISABLE the Tank Full Switch in the system settings. See System Settings instructions later in this manual.***

## Tank Switch Installation

### Optional Tank Low Switch

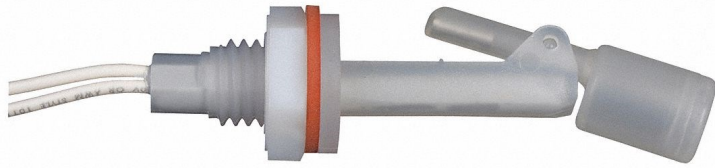

Installing the tank low float switch about 2/3rds down from the top of your water tank allows the Spectra Connect to run in Auto Fill mode; automatically filling your water tank, stopping itself, fresh water flushing, returning to Auto Store mode, and then turning itself on again to fill the tank when the water level drops below the Tank Low Switch with no additional user commands.

Drill 5/8" hole into the side of the fresh water tank that is being filled by the watermaker. This can be installed wherever there is convenient access to the tank, approximately 2/3rds of the way down from the top of the tank.

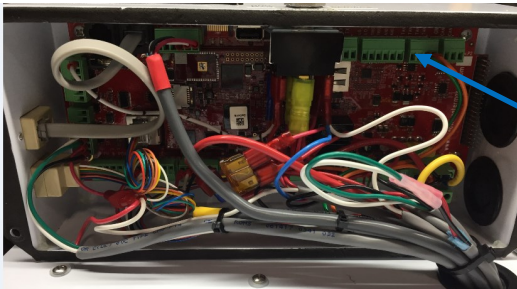

Tank Switch 2

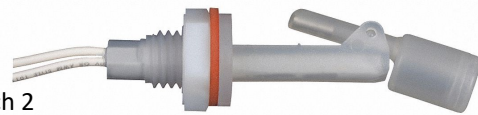

The float switch must be connected to the Tank Switch 2 terminals on the Spectra Connect control board at the Feed Pump Module. There is no polarity.

**For Instructions on enabling the 'Auto Fill' mode see the System Settings instructions later in this manual.**

**Watermakers should never be run unattended!**

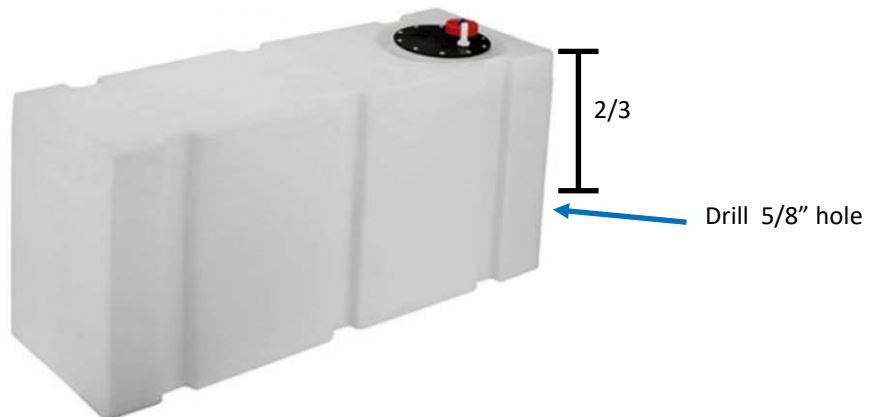

## Z-ION Installation

The Z-Ion replaces the fresh water flush module on the feed pump module. The Z-Ion filter bowl, like the normal fresh water flush module, houses the charcoal filter, which must be replaced every six months.

The Z-Ion control box comes with four-foot cables for flexibility in mounting on the bulkhead above or adjacent to the feed pump module.

Plug the connector from the Z-Ion generator bowl into the connector from the Z-Ion control box.

Connect the power/signal cable, marked green, from the Z-Ion control box to the Z-Ion control cable, also marked green, coming from the Spectra Connect box.

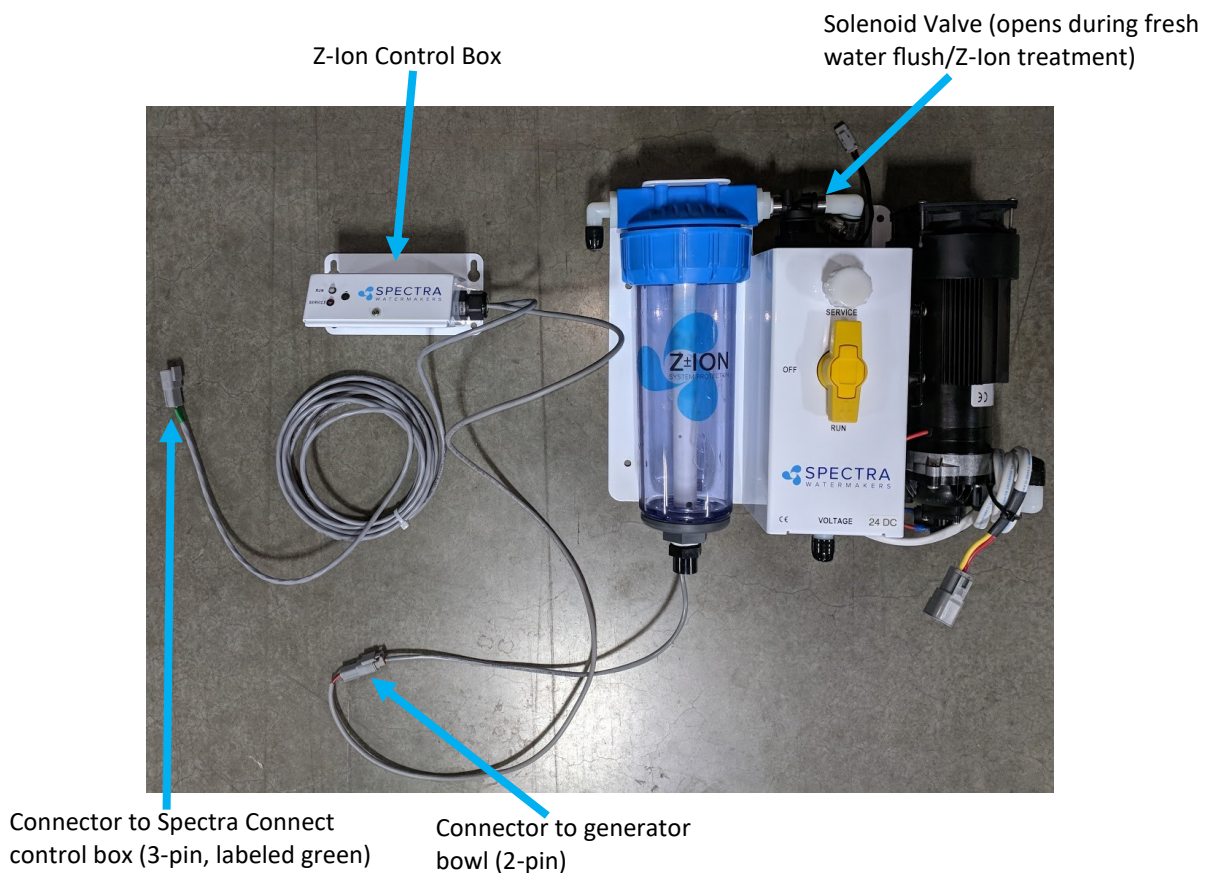

## Z-ION Operation and Installation

This revolutionary adaptation of an ancient technology effectively and safely protects the membrane and filters on your Spectra Watermaker from biological growth. Your system will be kept ready to operate without any additional flushing, external power sources, pickling chemicals, or complex procedures. The controller has been specifically designed to batch process (produce) metallic ions for system disinfection.

The process has been around for many years, however most systems produce ions on a continuous slow basis rather than a short intermittent process. We found that the most stable way to produce ions in a batch process is to maintain a constant current to the electrodes and vary the voltage. By being able to boost the voltage the amount of electrode surface area can be smaller to produce the needed ions in a brief period of time.

The Z-Ion should be energized at all times, but will only consume power when water is running through it. Upon initial power-up the LED will flash red/green and then will turn solid green.

Follow the instructions for Normal Operation and Fresh Water Flush (for treatment with the Z-Ion, the process is identical, only the Z-Ion will release silver and copper ions into the flush water.)

When fresh water flows, the operation cycle begins and the LED turn off, and only quick flashers of green and amber. The cycle will continue until either the flush cycle stops or the adjustable timer times out (factory set for 15 minutes).

If the voltage is out of range, below 10V or above 56V, the LED will flash red every two seconds and the unit will shut down.

Each fresh water flush with the Z-Ion will protect your watermaker for up to 30 days, after which the process must be repeated.

After 720 cycles the service light on the front of the control box will light up, indicating that the probes on your Z-Ion may be wearing down, and should be tested. The service light is just a reminder that your Z-Ion rods need to be inspected. Before resetting check that rods have not dissolved and are not touching.

To reset the service counter, touch two magnets, at the same time, to the two red reed switches on the Z-Ion circuit board, labeled Switch 1 and Switch 2 on the following page.

# Z-ION Layout and Specs.

Run Light  
Will be green when while Z-Ion is  
powered and ready



Service Light

There are 7 pins on the phoenix connector from left to right:

- Pin 1 Supply Voltage-Battery ( + )
- Pin 2 Ground
- Pin 3 Trigger
- Pin 4 Auxiliary Output 1
- Pin 5 Auxiliary Output 2
- Pin 6 To ion generator (bowl). No polarity.
- Pin 7 To ion generator (bowl). No polarity.

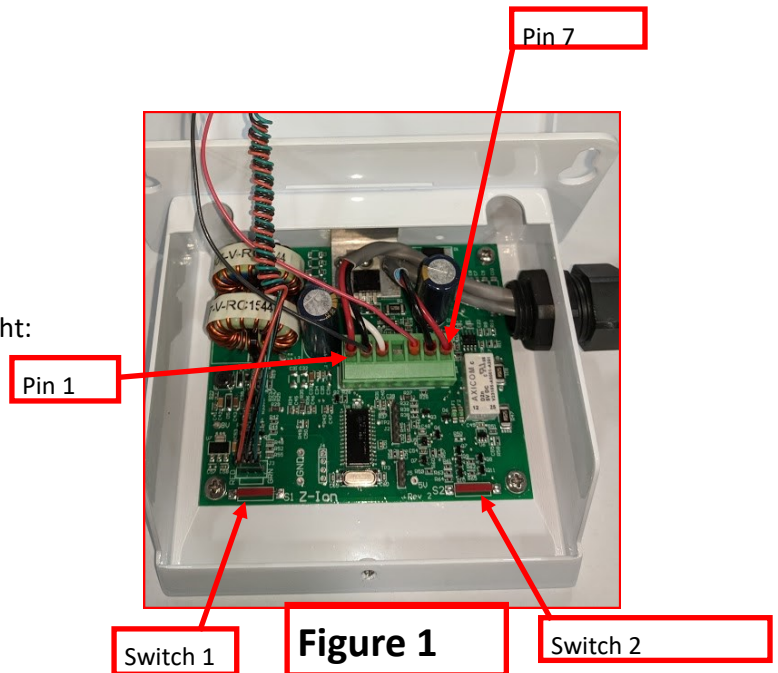

Auxiliary Outputs 1 and 2 are switched to the supply voltage when turned on. These outputs are protected by 100mA self resetting fuses.

Output 1 – ON during generating cycle – intended to drive a pump relay on some systems

Output 2 – ON when cycle counter reaches pre-programmed number (usually 720), when generator element may need replacement and should be tested and/or inspected.

## Operation – LEDS

Power-up indication – fast red/green flash for a few seconds

Ready, Idle – solid green

**Generating – the LED will quickly flash at a programmed interval (factory set to 17 seconds between flashes.)**

**The flash color will alternate between green and amber and will be off in between voltage spikes. The color change symbolizes the polarity alternating from positive to negative.**

Bad power – fast red flash followed by shut down

High temperature – fast red flash

Cycle counter reached limit—slow red flash

# Operation



# New System Start-Up and Testing

Avoid running the Ventura system if the vessel is in contaminated water. The system should be fully tested before leaving port. If the location or weather prevents proper testing, refer to **Dry Testing with an Artificial Ocean** on page 34.

**Warning! Damage may occur if the purge sequence is bypassed and the membrane is pressurized with storage chemicals in it.**

First check:

- Thru-hull inlet and the brine discharge valves are open.
- All of your hose connections are tight.
- The washer with the green tag under the pressure relief valve has been removed.
- The pressure relief valve is open 1/2 turn.
- The toggle switch on the Connect control box is set to the Auto position.
- There are at least several gallons of water in your fresh water tank for priming.

**Remove Tag and Washer!**



**Open 1/2 Turn when purging chemicals!**



3. Turn on the power to the system and the Spectra Connect screen will display, “Has the system been stored with chemicals?” Press ‘Yes’, to start the Purge sequence. Note: The watermaker will shut down if the pressure relief valve is left closed during the Purge mode.

- Alarm will sound
- Display will read “Has the system been stored with chemicals?”
- Confirm the Pressure Relief Valve is open
- Press ‘Yes’ to start the Purge sequence

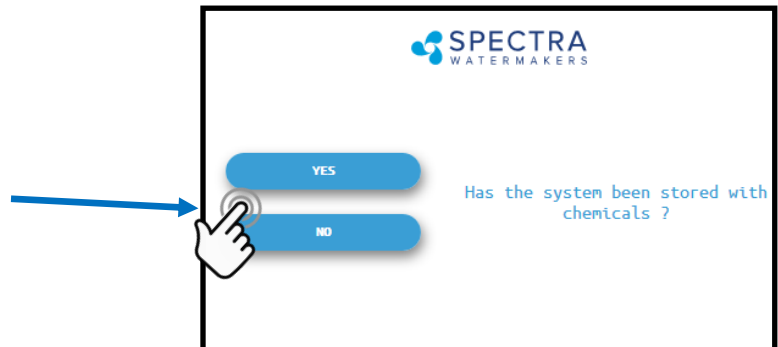



## New System Start-Up and Testing - Cont.

- The system will start purging and the display will show the progress and time remaining

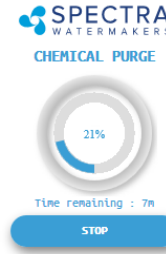

Check the strainer and the brine discharge for water flow. The system should fully prime within 60-90 seconds and all air should be out of the feed water hoses. The feed pump will sound smooth.

There should be no bubbles anywhere in the intake hoses. **If the feed pump continues to sound rough, find the reason before continuing!** Inspect the system for leaks.

**Note:** If you must stop the purge sequence for any reason, the control will default back to the beginning of the purge mode to protect your system. *If the system is new from the factory, or stored with Propylene Glycol, additional purging time may be required.*

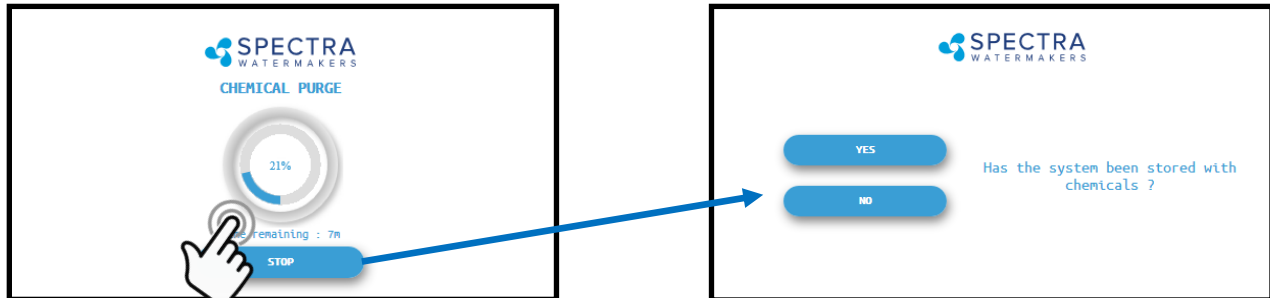

- After the purge sequence the display will alarm with the message “Close pressure relief valve.” **Close the valve** and proceed by pressing **Ok** to resume the Purge Cycle.

**Note:** If system stays on ‘Boosting Pressure’ screen, flip metal toggle switch to Run Manual until it reaches 15psi and progresses to next screen, then move toggle switch back to Run Auto.

- The system will now run under pressure and desalinate water. This mode diverts the product water overboard in case there is any residual chemicals in the membrane. **Carefully inspect for leaks over the entire system!** Shut down the system and repair any leaks you find.



- After the Product Purge cycle completes, the system will prompt to **Restart**, then advance to the Main Menu. **If this is a NEW INSTALLATION, continue to the Calibration Instructions to finalize the installation.** If you are putting your watermaker back into service, your system is now ready for use.

## Dry Testing with an Artificial Ocean

If it is not possible to test run the system with the boat in the water, you may test the system with an artificial ocean. You will need 1.3 lbs. of non-iodized salt (rock salt, sea salt, or aquarium salt) to make a 5 gallons (33 grams of salt per liter) of water that is about 33,000 PPM salinity (average seawater salinity). Make sure the domestic water system is powered up and the boat's tank has at least 60 gallons (230 Liters) of water to purge the storage chemicals from the system. Confirm that the charcoal filter is installed in the feed pump module, and the domestic water line is connected.

1. **Open the pressure relief valve on the Clark Pump. Remove the green tag and spacer.**
2. Power up the system. When the Spectra Connect displays “Has the system been stored with chemicals?”, select “No” to bypass the purge mode.
3. Press the **Fresh Water Flush** button to run a full flush cycle. Do this **six** times to purge the storage chemicals, a 36 minute process.
4. Connect the inlet service hose to the service port on feed pump module, then connect the brine discharge service hose to the quick disconnect fitting on Clark Pump. Refer to the photo below. Route both hoses into the 5 gallon (20 Liter) container. Turn the product sample valve to the sample position, and route the **product** into the bucket.
5. Using the display select fresh water flush, do this until the bucket is filled with fresh water.
6. Mix salt with the fresh water to the proper proportion or use an aquarium hydrometer to adjust the salinity level.
7. Push the **Start** button, then press **Auto Run** and program the Connect to make **10 gal (38 L)** of water, roughly 40 minutes of operation.
8. Allow the system to prime and then close the pressure relief valve. The system should build pressure shortly and start making water, with the brine and product water recombining in the bucket to be cycled again. This will gradually heat the water. Do not let the water temperature exceed 120 deg. F (49 deg. C).
9. Run the system under pressure, checking for proper operation and leaks. After testing the system, re-install the brine discharge hose, product tube, and fresh water hose from the strainer. You can now flush the system by pressing the **Fresh Water Flush** button.

Remove tag and washer



Open the pressure relief valve  
On Clark Pump:



Connect the brine discharge service hose:



# Sensor Calibration

Many of the settings on your system have been pre-calibrated during standard factory testing, however, there are a few settings that will vary based on the installation, vessel, and other onboard conditions. **If the system has just been installed you must calibrate the Prefilter Condition before proceeding.**

## Prefilter Condition Calibration

This procedure does **not** need to be done with each filter change under normal operation, it should **ONLY BE DONE IF THE FILTER CONDITION WON'T RESET TO 100% WITH NEW FILTERS AND A CLEAN/NEW STRAINER SCREEN.**

1. During the calibration sequence the system will automatically start, begin to make water for several minutes and then shut itself down. *Make sure that the filters have been replaced for new, the strainer is clean, and all thru-hulls are open before proceeding.*
2. Follow the steps in Figures 1—4 below to initiate the Calibration Sequence.



Fig. 1

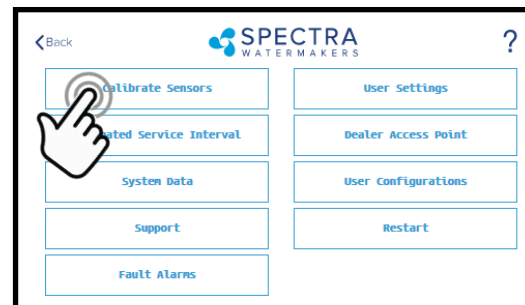

Fig. 2

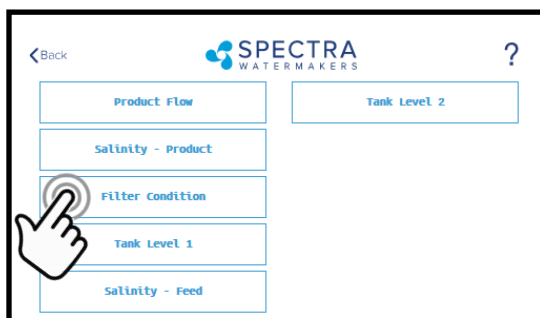

Fig. 3



Fig. 4

3. When the Calibration Sequence is complete, press the **<Back** button in the upper left corner to return to the Main Menu.  
*When prompted by the display, Click Save to make sure that the Calibration is stored in the system memory.*



4. The Filter Condition has now been calibrated.

# Sensor Calibration

## Flush Adjustments

The Ventura Flush Duration is set to a factory default of 3 minutes, which is usually the right amount of time to ensure that sea water is thoroughly flushed out of the watermaker using the least amount of fresh water. However, due to different lengths of hose runs, different rates of flow, and different pressures in shipboard fresh water systems, the flush duration can be optimized for your boat.

Detailed instructions about how to access the programming function and set the flush duration can be found on page 70, Programming From the Display. Set the Flush Duration so that the fresh water flush comes to an end just as the salinity of the brine discharge drops below 1000 PPM, or no longer tastes brackish. Since the flush duration can only be adjusted in round minutes, you may want to lessen the duration to 2 minutes, to save water, or increase to 4 minutes to ensure a thorough flush.

Also, the charcoal filter is rated for 1.5 GPM (6 LPM): If the system pushes more than 1.5 GPM through the charcoal filter (4.5 gallons in 3 minutes), a flow regulator can be added.

## Tank Level Sensor Calibration

Follow the steps in Figures 1—4 laid out below to enter the calibration sequence for the optional Tank Level Sensor(s).

1. Press the Menu Button



Fig. 1

2. Press the Calibrate Sensors Button

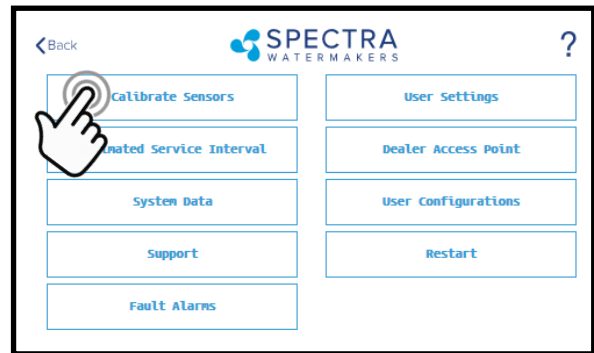

Fig. 2

3. Press the Tank Level 1 button

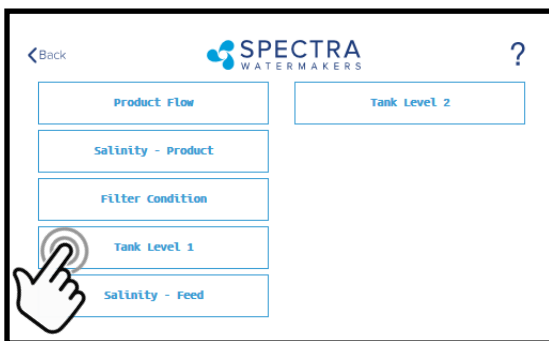

Fig. 3

4. Fill the fresh water tank to be monitored.



Fig. 4

## Tank Level Sensor Calibration - Cont.

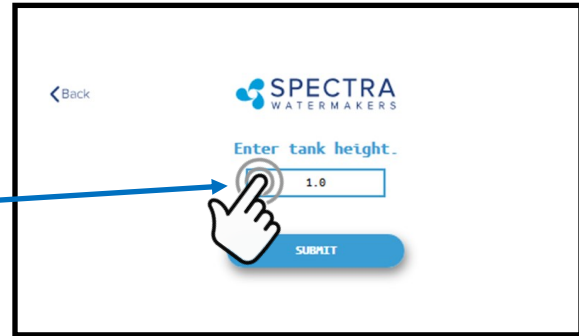
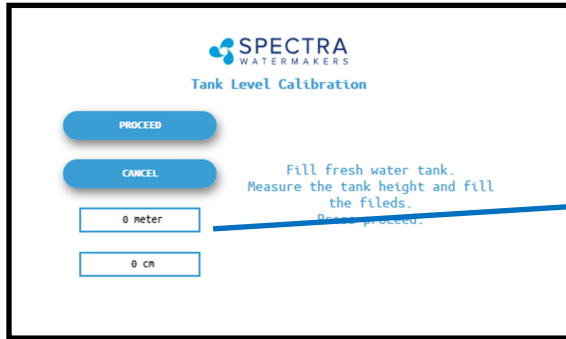

5. Measure the approximate height of the water tank in feet and inches (or in meters and cm's).
6. Press the Feet (Meter) field to enter the tank height in feet (meters). Press the Inch (cm) field to enter the height in inches.

Ex: If the Tank height is 150cm:  
Enter '1' in the field labeled 'Meter'  
Enter '50' in the field labeled 'cm'

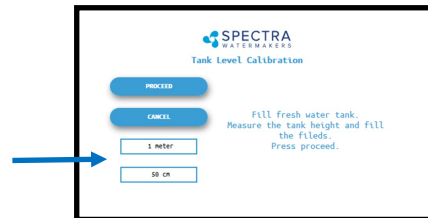

7. Press 'Submit' and confirm your entry matches your measurement.

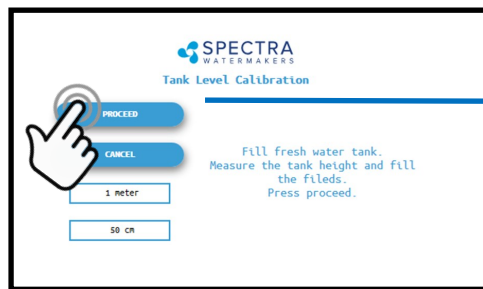

8. You must save all changes when prompted after exiting the settings menu.

# Salinity Calibration

The Salinity probe has been calibrated at the factory during testing and is not normally required during commissioning. If the product quality is not reading accurately, follow calibration steps.

1. Press the Menu Button

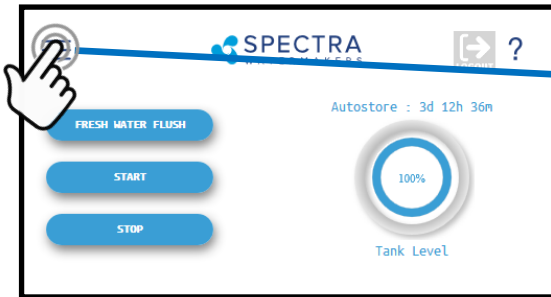

2. Press the Calibrate Sensors Button

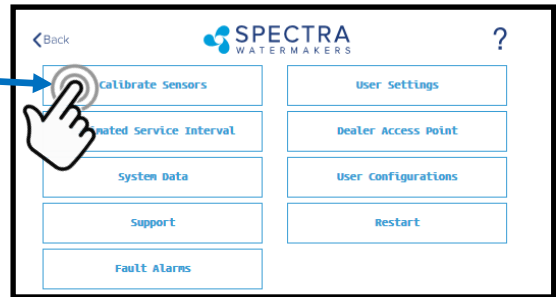

3. Press the Salinity—Product Button



Fig. 1

4. Press Continue to acknowledge the warning



Fig. 2

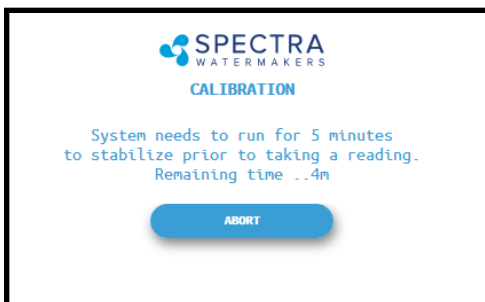

Fig. 3

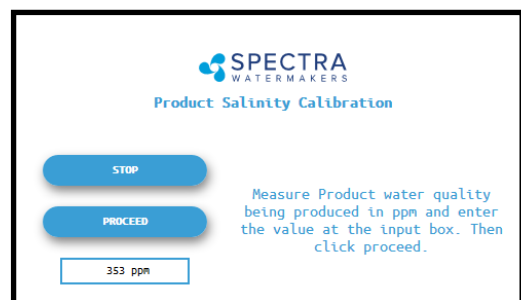

Fig. 4

5. The system will run for a minimum of 5 minutes to stabilize the product water salinity.
6. Using a calibrated handheld TDS meter measure the salinity of the product water at a sampling port, or a convenient location if no sampling valve was installed.
7. Touch the 'PPM' field and enter the reading taken above.
8. Press 'Proceed' to store the new calibration value. *You must save all changes when prompted after exiting the settings menu*

# Product Flow Calibration

The Product Flow Sensor has been calibrated at the factory during testing and isn't normally required during commissioning. If the product flow is not reading accurately, confirm the product flow rate by following the Product Flow calibration steps.

## 1. Press the Menu Button

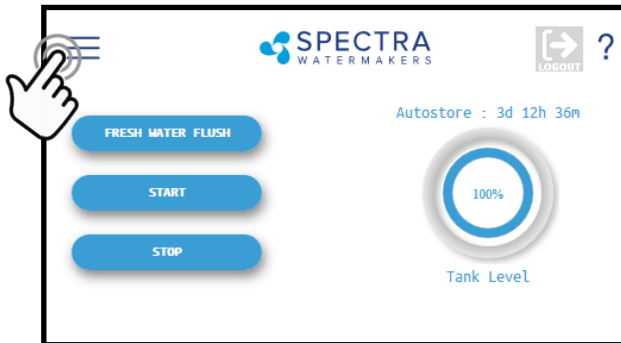

## 2. Press the Calibrate Sensors Button

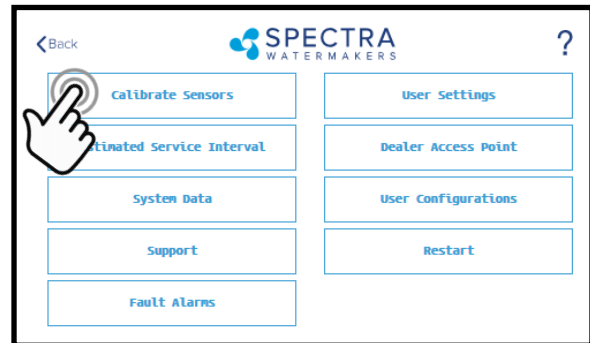

## 3. Press the Product Flow Button

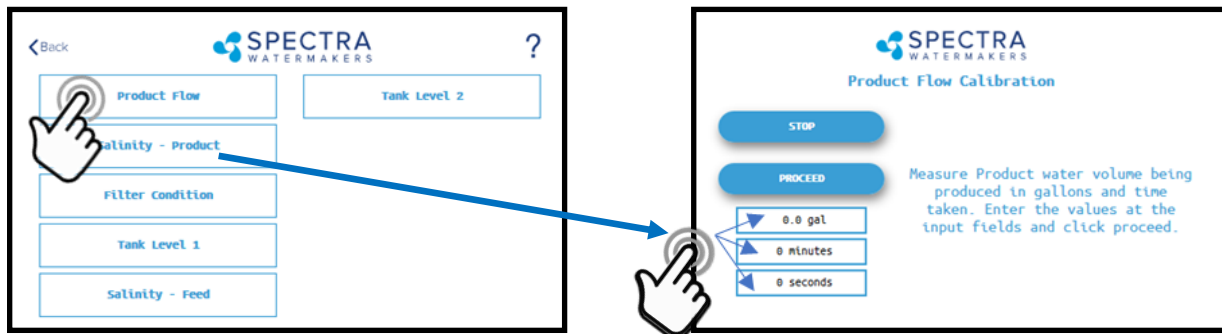

- Once the system has started and a steady stream of water is flowing from the product water tubing, time in minutes and seconds, how long it takes to fill a container of a known volume.
- Touch the 'Gal' ('Liter') field to enter the volume of the container used.
- Touch the 'Minutes' field to enter the minutes it took to fill the container. *Only enter the minutes, ex: 3 min 15 sec should be entered as 3.*
- Touch the seconds field to enter the seconds it took to fill the container. *Only enter the seconds, ex: 3 min 15 sec should be entered as 15.*
- Press 'Proceed'. *You must save all changes when prompted after exiting the settings menu*

# Networking

Your Spectra Connect is equipped with state of the art networking options to allow the maximum user control in a wide variety of installations. The instructions below will help you get the most out of your Spectra Connect.

*Note: Your Spectra Connect is only available when your device is connected to the same local network as the Spectra Connect control board. If you have difficulty connecting to your watermaker control application, double check that your device network is the same as your Spectra Connect*

## Connecting to the existing Network

1. Turn power to the system off.
2. Connect a standard Cat5e or Cat6 ethernet cable from jack labeled network to your ship's router or networking switch.



3. Turn power to the system back on.
4. Follow the screen prompts below:

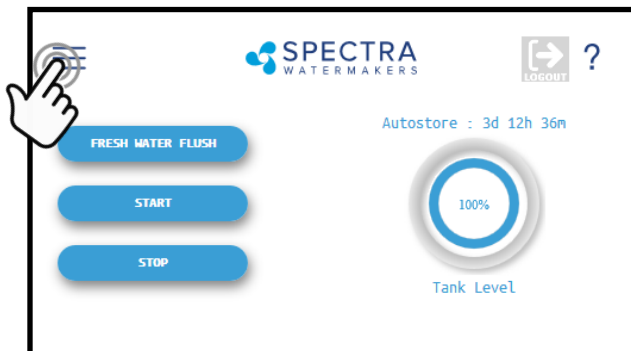

Fig. 1

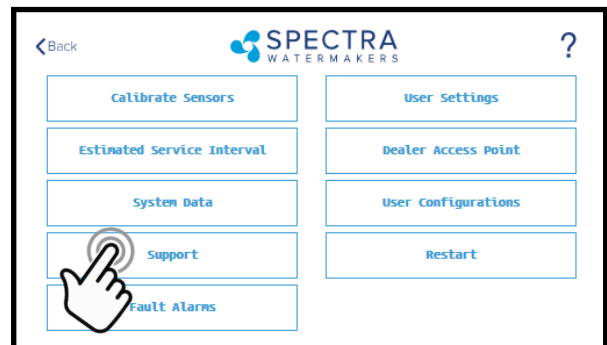

Fig. 2

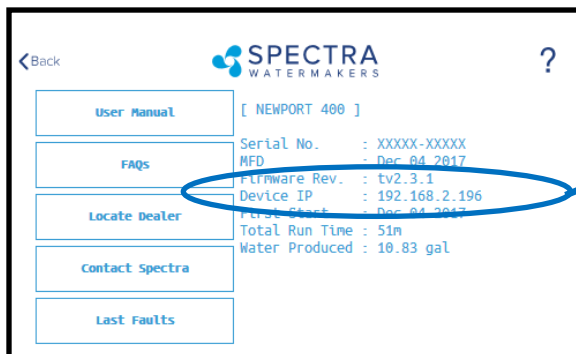

Fig. 3

Firmware Rev. : tv2.3.1  
Device IP : 192.168.2.196  
First Start : Dec 04 2017

5. Note the line 'Device IP' shown in Fig. 3 and record the 10 digit numerical address on the front of this manual.



## Connecting to the existing Network - Cont.

6. Connect your computer, tablet or smart phone to the local network your Spectra Connect is plugged into.

**Wired Connection:** simply plug your computer's ethernet port directly into the router or switch where you connected the watermaker.

**Wireless Connection:** make sure your device is connected to the same local wireless network as the Spectra Connect

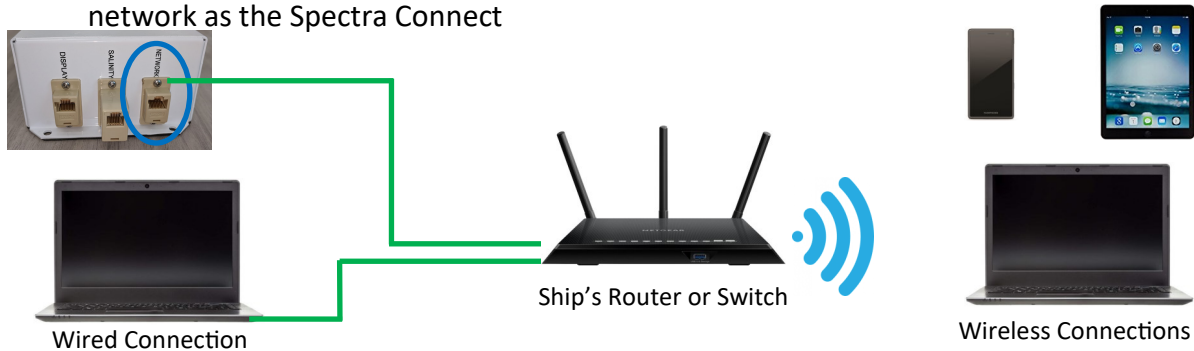

7. On the computer, tablet or smartphone, open a web browser such as Firefox, Chrome, or Safari. In the web address bar at the top, type the 'Device IP' address previously recorded. Press 'Enter'.

**Note: Internet Explorer may not be compatible with your Spectra Connect web app. If formatting issues occur, use another browser such as Firefox, Safari, or Chrome.**

Ex: Address Bar—Firefox

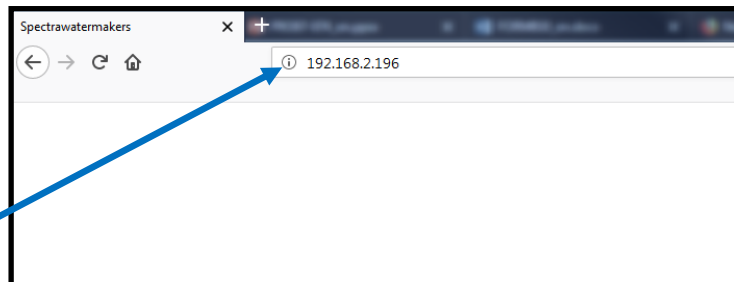

8. Your computer should now show the same image as shown on your local Spectra Connect

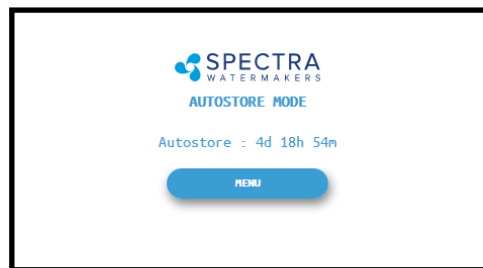

9. Your web browser is now synced with your Spectra Connect. Any buttons you press on your web browser will be controlling your watermaker.

**Caution! If operating your watermaker from a computer, phone, or tablet, you must keep the tab open while the system is in operation and the volume turned up on your device in order to hear any audible alarm faults.**

# Normal Operation

If the system has been pickled or stored with chemicals, use the New System Startup procedure on page 23.

Your watermaker will fresh water flush **after every use**. Remember that you need to run the system approximately half an hour to make enough fresh water for one flush.

You may notice that the system output is higher when charging your batteries. This is normal.

1. Check to see that the inlet and brine discharge seacocks are open and the domestic pressurized water system is turned on.
2. Press the 'Start' button, then select the desired operating mode.

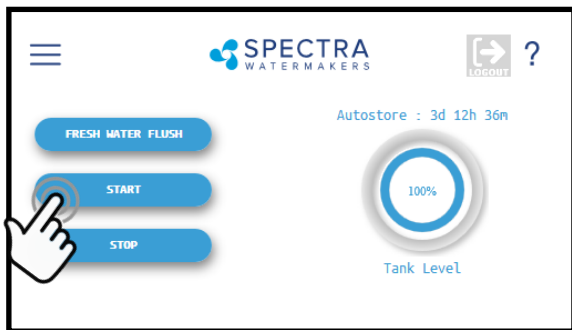

## Standard Operating Modes



Runs your watermaker until the Tank Full switch closes, fresh water flushes the system, then goes into 'Auto Store' mode and the Flush Interval timer starts. *This is the default mode of operation.*



Gives you the option to run for a preset amount of time, or a preset volume of water to be produced. **If no tank switches are installed, and they have been disabled in the system settings, this is the only Operating Mode available.**

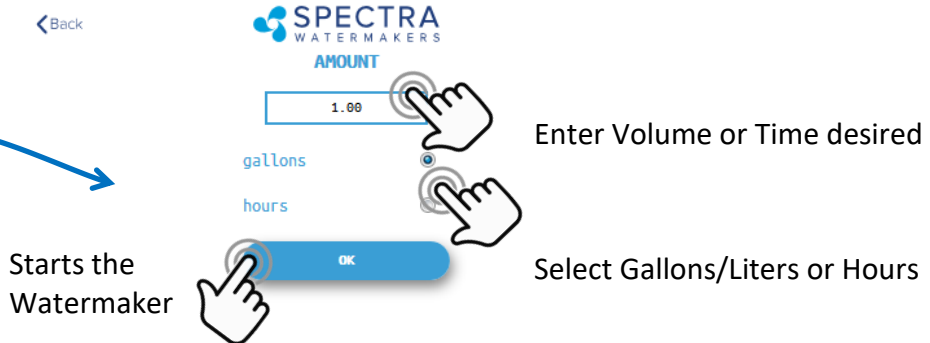

## Normal Operation - Cont.

3. The system will now begin the start sequence. Pressing 'Stop' will bring you back to the Main Menu.



4. Once the Boost Pressure reaches the minimum threshold, the system starts operating and you will be taken directly to the Main Dashboard.

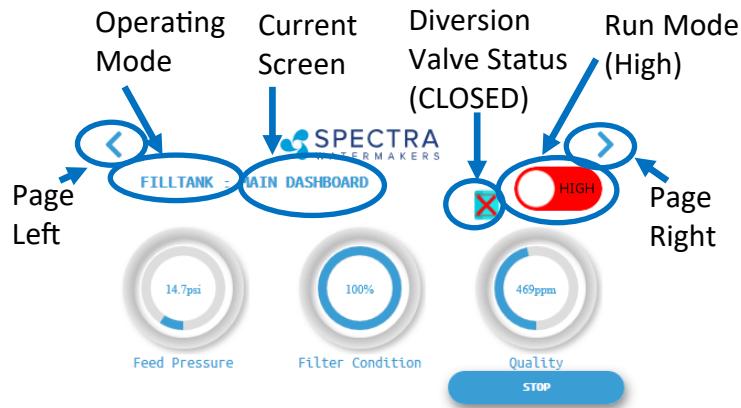

6. When the Product Water Quality is below the programmed threshold, the Diversion Valve opens, allowing water to enter the tanks and the screen image changes.

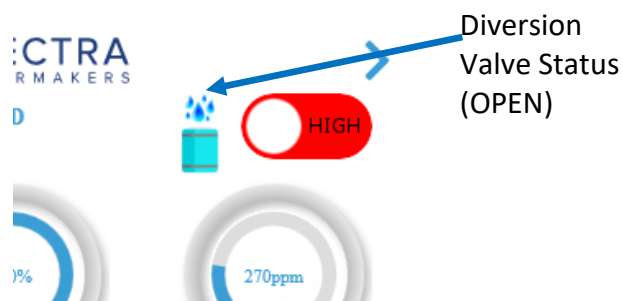

Verify that the system is operating according to the factory specifications detailed on p.36. See the Troubleshooting section to identify any anomalies.

7. Pressing the < (Page Left) or > (Page Right) arrows will show a different screen with different operating information for your watermaker.

## Normal Operation - Cont.

8. When the Run Cycle completes, or by pressing 'Stop', the system will start to Fresh Water Flush. **You MUST FRESH WATER FLUSH the watermaker AFTER EACH USE, or serious damage can occur.**



8. After Fresh Water Flushing the system will enter the 'Auto Store' mode, and the interval timer until the next scheduled flush will show on the screen.

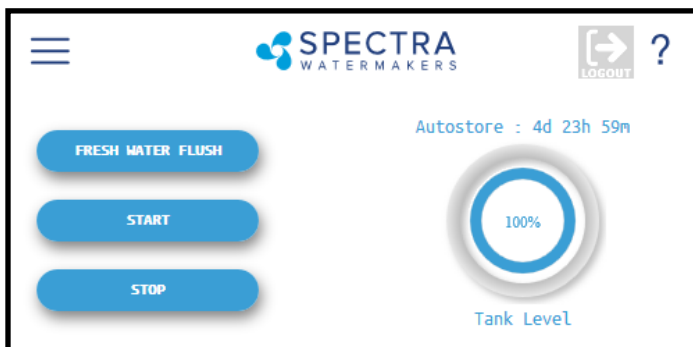

## Nominal Operating Parameters

To access this information about your watermaker while it is running press the < or > buttons to scroll through the pages.

Parameter	Minimum	Maximum
Product Quantity	5.7 GPH (21.5 LPH)/Ventura 150 7.7 GPH (29.1 LPH)/Ventura200	6.5 GPH (24.6 LPH)/Ventura 150 8.3 GPH (31.4 LPH)/Ventura 200
Product Quality	<300 ppm	750 ppm
Feed Pressure	N/A	70 psi (5 bar)/Ventura 150 90 psi (6.3 bar)/Ventura 200
Amp Draw Ventura 150	9.0A @ 14VDC; 4.5A @ 26VDC	
Amp Draw Ventura 200	10.0A @ 14VDC; 5A @ 26VDC	
Total Flow (Brine + Product)	1.65 GPM (6.2 LPM)	

## Normal Operation - Cont.

### Other Operating Modes

#### Run Low Mode

You can toggle back and forth between Run High Mode and Run Low Mode by tapping the 'High' toggle button.

Run Low Mode may be selected to reduce power consumption or to lower the feed pressure.

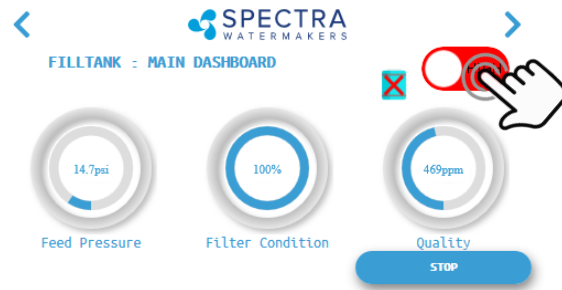

*Note: The system will automatically drop to Low Mode when it senses high feed pressure, or dirty prefilters.*

#### Auto Fill Mode

If your vessel is equipped with a Tank Low and a Tank Full switch, **and both are enabled in the system settings**, then your Start Menu will allow the system to be operated in Auto Fill mode.



**WARNING: NEVER RUN YOUR WATERMAKER UNATTENDED. EQUIPMENT CAN BE SERIOUSLY DAMAGED, AND IT IS POSSIBLE TO SINK THE VESSEL!!** Use extreme caution when operating in Auto Fill mode!

In Auto Fill Mode the Spectra Connect will automatically fill your water tank, stop itself, fresh water flush, return to Auto Store mode with the flush interval timer running, and then turn itself on again to fill the tank as soon as the water level drops below the Tank Low Switch with no additional user commands.

Additionally, if power is interrupted at any stage of operation, the Spectra Connect will return to Auto Fill mode, ensuring that your tanks will always have water.

## Normal Operation - Cont.

### Auto Store

**Warning!** Proper understanding of the Spectra flush system and the vessel's fresh water system is mandatory for extended use of Auto Store. **The flush cycles must not be allowed to drain all the fresh water from the tank or damage to the vessel's systems and the watermaker may occur.**

The Auto Store function flushes the watermaker at programmed intervals. As long as the watermaker is flushed with fresh water every 5 days (30 days with the Z-Ion) you need not store the system with chemicals.

- **Make sure there is enough water in the fresh water tanks to supply the watermaker for more than the expected time of operation in the Auto Store mode.** If there isn't enough fresh water in your tank, seawater will be drawn in and the system will not be flushed with fresh water. The Catalina 340c requires about 7 gallons (26 liters) for each flush. **The boat's pressure water supply must be on and stay on** while the system is in Auto Store mode. *If these conditions cannot be met, then pickling with SC-1 storage chemical or propylene glycol is preferable.*
- Make sure the pressure relief valve on the Clark Pump is closed.
- **The system must be continually powered on during the Auto Store mode.** Turning off the power will disable the automatic fresh water flush and damage may occur.

Flushes the system with fresh water, then activates the flush interval timer:

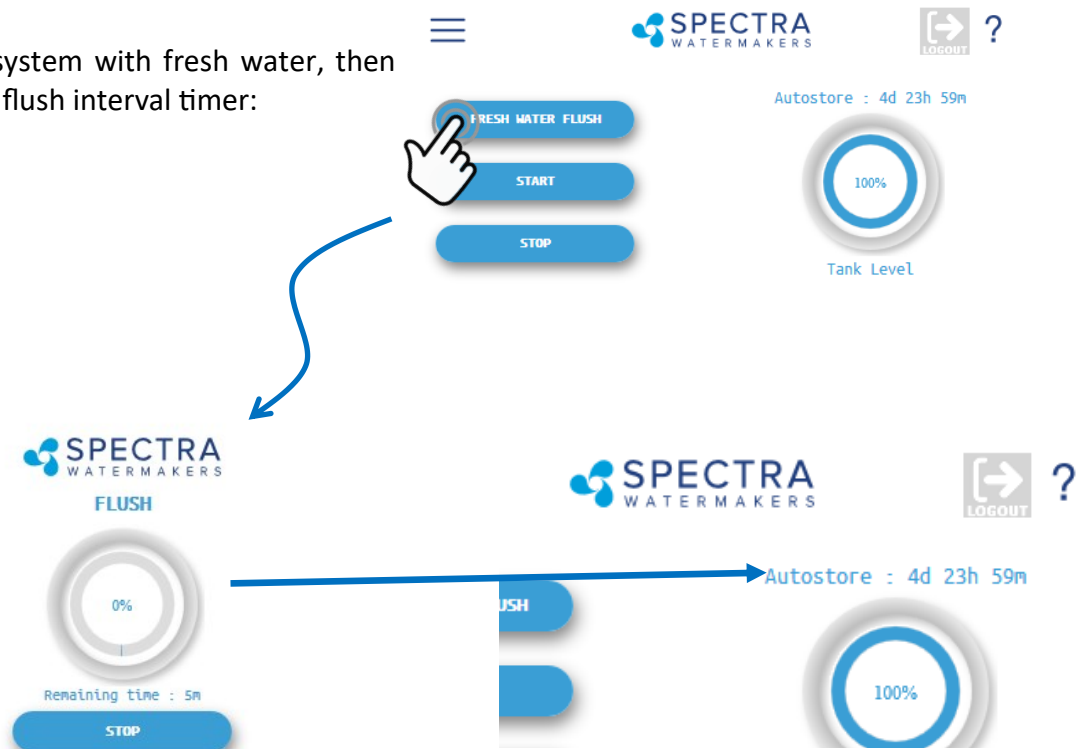

# Maintenance

## General

Periodically inspect the entire system for leakage and chafing. Repair any leaks as soon as you find them. Some crystal formation around the Clark Pump blocks is normal. Wipe down any salt encrusted areas with a damp cloth.

Watermakers are at their best when run regularly. Biological fouling in the membrane is more likely when a watermaker sits idle. A warm environment will cause more growth than a cold environment. A fresh water flush every five days (30 days with the Z-Ion) will greatly reduce biological growth, but may not stop it completely. The Z-Ion system protects the membrane from bio-fouling without the use of storage chemicals.

## The Seawater Strainer

The seawater strainer's stainless steel element should be inspected, removed, and cleaned as needed. Ensure that the thru-hull is closed before disassembly and the gasket is in place before reassembly. When the system is put into storage, remove the strainer, rinse with fresh water, and reassemble dry to impede corrosion. Check frequently during operation.

## The Prefilters

Service the prefilters as soon as possible after the prefilter condition graph begins to rise. If the filter condition graph gets all the way to "Replace" the machine will slow down. When display reaches "Replace" a second time, the alarm will sound and the system will shut down to prevent damage. **Please review prefilter bulletin to page 58. prior to running your system.**

Prefilter elements must be changed frequently. The rate is solely dependent on the input water. A 5-micron filter might last you a 4-6 weeks in clear open ocean seawater, or be ruined in minutes in a dirty harbor. Spectra does not advise to attempt to clean dirty prefilters. Prefilters are a consumable item and should be changed for new when in question.

To service the filters close the thru-hull, open the housings, remove the old filters, clean out the housing bowls, and reassemble the housings with new 20 and 5 micron filter elements. The 5 micron filter goes downstream from the 20 micron. Leave dry until next startup.

**Note:** Use only Spectra-approved filters or you may void your warranty. Occasionally, lightly lubricate the O-rings with silicone grease.

## Oil/Water Separator (Optional)

To install oil water separator capability, add a second filter housing UPSTREAM of the 20 and 5 micron housings. Service as you would per the instructions above.

## The Charcoal Fresh Water Flush Filter

Replace the charcoal filter element at least every 6 months. This filter protects the membrane by removing chlorine from the flush water. Use only a Spectra-approved replacement.

## Maintenance - Cont.

### The Feed Pump and Clark Pump

The feed pump and the Clark Pump require no routine maintenance except inspection for leaks. Tighten any hose clamps or fittings that show signs of leakage. The high pressure fittings threaded into the Clark Pump have O-ring seals with a straight thread. These should never leak and should never be over-tightened. If one of the tube nuts starts to leak, it can be un-threaded, sealed with a bit of silicone grease or oil, and tightened with two wrenches very tightly.

### The Membrane

Membranes are susceptible to mineral scaling, biofouling and oxidation damage. The leading cause of fouling is biological growth that forms when the system is left unused without flushing or pickling. Fouling from mineral scaling can happen under certain seawater conditions, or from rust. Oxidation damage can occur if the membrane comes into contact with any strong oxidant, such as Ozone, Chlorine, etc. Monitor the product salinity and feed pressure for higher than normal readings, take environmental conditions into consideration.

Note that:

- Cold feed water or a higher salinity seawater source can cause high pressure.
- Low product flow is usually due to low voltage, a worn feed pump, or worn Clark Pump.

Due to the unique design of your Spectra system, low product water volume is typically not a membrane problem, but frequently related to low voltage, a worn feed pump head, or a worn Clark Pump. Always perform a flow test before cleaning your membrane.

**Test to see if biological growth has occurred:** Before running the system, remove the prefilters and examine their condition. If the filter housings are full of smelly, discolored water, the system was not properly stored. Install clean prefilters.

Next check the membrane. Detach the brine discharge hose, attach the brine service hose, and lead it to a bucket. Open the pressure relief valve 1/2 turn, and manually run the system for 30 seconds (metal toggle switch on feed pump module). Examine the brine water: If it is discolored and smells bad, perform an SC-2 cleaning with unchlorinated water before running the system pressurized. If the brine is fairly clean, follow the New System Startup procedure on page 24 and run normally. Check for performance. Clean the membranes **only if** performance is reduced.

See the **Cleaning Procedure** for complete instructions.



# Maintenance - Cont.

## Introduction to Spectra Chemicals

We use four types of chemicals: SC-1, SC-2, SC-3, and propylene glycol antifreeze. SC-1 and propylene glycol are for system storage, while SC-2 and SC-3 are for membrane cleaning. **Do not use sodium-bisulfate, citric acid, or any other storage chemical not supplied by Spectra.** These chemicals, used to store other watermaker brands, will damage the Clark Pump, membrane end plugs, manifolds, and other components. **Using non-Spectra chemicals will void the warranty.**

**Note: Never use any chemicals with the system pressurized!** Always open the pressure relief valve 1/2 turn. Always follow the instructions for purging the chemicals as shown in the New System Startup section (page 39) of your owner's manual.

## Storage

SC-1 prevents biological growth when your system is idle. It should not be used as a cleaning chemical, nor will it protect your system from freezing. A jar of SC-1 is mixed with 1 to 2 gallons of product or dechlorinated fresh water in a bucket and circulated through the system for 10 minutes. This treatment will protect the system for six months, after which the SC-1 treatment must be repeated. To use SC-1, follow the instructions for **Storage Procedure**.

Spectra systems should be stored with propylene glycol if freezing is likely to occur. Propylene glycol can be used instead of Spectra SC-1 storage chemical for storage in any climate, and treatment is effective for one year. Propylene glycol is a food-grade antifreeze used to winterize RV's, boats, and cabins. Do not use ethylene glycol automotive antifreeze, which is toxic and will damage the system.

The propylene glycol formulations sold in marine and RV stores are usually diluted with water. The water remaining in the watermaker before the storage procedure will further dilute the antifreeze, reducing the microbial protection and increasing the temperature at which the mixture will freeze.

Antifreeze labeled "Minus Fifty" is a 25% solution and will begin to form an icy slush at about +15Degrees F (-10C) and will only provide burst protection to about Zero F (-18C). After a further 50% percent dilution by water remaining in the watermaker, "Minus Fifty" antifreeze will only protect from bursting down to about +25F (-4C). Therefore if low temperature freezing protection is required a 60% or stronger antifreeze should be used. 60% solutions are labeled "Minus 100" and will provide burst protection to -15F (-27C) even after a fifty percent dilution with residual water. "Minus 200" formulations are pure propylene glycol.

## Maintenance - Cont.

### Introduction to Spectra Chemicals—Cont.

Complete microbial protection requires a 25% solution of propylene glycol, so care must be taken that the solution remaining in the watermaker during long term storage is at least 25%, even if freeze protection is not required. For these reasons Spectra recommends that all pickling be carried out with a 60% or greater concentration.

See **Winterizing with Propylene Glycol**.

Propylene glycol can be difficult to flush from a membrane, especially after extended storage periods. This results in high salinity water (high PPM) and residual flavor in the product water. We recommend flushing the system WITH THE PRESSURE RELIEF VALVE OPEN for 4-6 hours after storage with propylene glycol—the longer the better. If, after extended flushing, you still experience low product water quality, cleaning with SC-2 usually removes all traces of propylene glycol and returns the salinity to the level it was before storage with propylene glycol. See the **Membrane Cleaning Procedure**.

### Cleaners

Avoid unnecessary cleaning, and avoid cleaning as a diagnostic tool.

**SC-2** is an alkaline cleaner used to remove light oil, grime and biological growth. It is most effective if heated to 120 deg. F (49 deg. C). In most cases the water quality will increase in PPM (salinity) after an SC-2 cleaning. After a few hours it should recover to near the level it produced before the cleaning.

**SC-3** is an acid cleaner used to remove mineral and scale deposits. In most cases this is used first and if there is no improvement, go on to the SC-2 cleaning. SC-3 will in most cases lower the product PPM and overall pressures. Scaling is a slow process that may take several months or years.

For cleaning with either SC-2 or SC-3, see **Membrane Cleaning Procedure**.

# Ventura Connect Storage Procedure

1. Turn the yellow service valve on the feed pump module to OFF (horizontal, see photo).
2. Push **Auto Store** to fresh water flush the system. Repeat, to flush the system twice.
3. Remove the cap on the service port on the feed pump module and install the inlet service hose from the service kit. Remove the quick disconnect fitting from the brine discharge outlet of the Clark Pump, and replace it with the quick disconnect brine discharge service hose. Lead both hoses to a 5 gallon bucket.
4. Push the **Auto Store** button and run the feed pump until you have one gallon of fresh water in the bucket from the brine discharge service hose. Stop the system.
5. Mix 1 container of SC-1 storage compound with the water in the bucket.
6. **Make sure the pressure relief valve on the Clark Pump is OPEN (un-pressurized) by turning 1/2 turn counterclockwise**
7. Place the yellow service valve in the Service position (pictured below).
8. Turn on the feed pump using the manual control switch on the Spectra Connect Control Box. The solution will be drawn from the bucket with the service hose, and returned to the bucket from the brine discharge service hose. Circulate the storage chemical in the system for approximately 10 minutes. Turn off the feed pump.

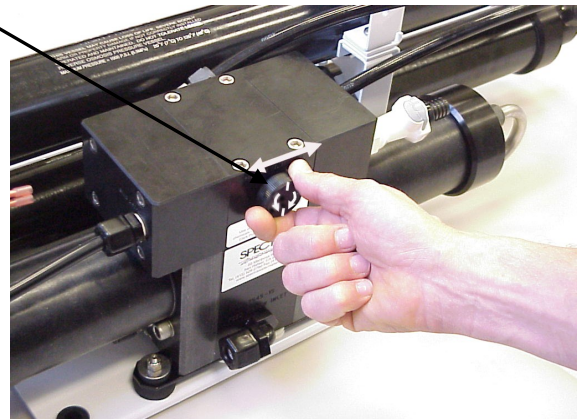

## Clean Up

Remove the brine discharge service hose from the Clark Pump, and replace the brine discharge hose that leads to the thru-hull. You may now pump the bucket dry by using the manual control switch on the Spectra Connect Control Box.

Turn the service valve 180° back to the RUN position, and remove the inlet service hose. Close the seacock, drain and clean the strainer and any filters in the system. Reassemble dry. Leave the pressure relief valve open, since the next time you run the system you will need to purge the storage chemicals with the system unpressurized.



Service valve OFF



Service hose connected and service valve to SERVICE



Connecting brine discharge service hose

# Winterizing with Propylene Glycol

*See description of propylene glycol formulations, and flushing from system, on page 44-45.*

1. .
2. Pour 1 gallon (4 liters) of propylene glycol of appropriate concentration (see pages 46-47) into the bucket with the intake service hose.
3. **Make sure the pressure relief valve on the Clark Pump is OPEN 1/2 turn (un-pressurized).**
4. Run the feed pump using the manual switch on the Connect control box until about a gallon of water has flowed from the brine discharge service hose, or antifreeze appears. Propylene glycol will look slightly different, and feel more slippery, than water. Stop the pump. Add more propylene glycol to the intake bucket if necessary.
5. Run the feed pump and circulate the antifreeze for 10 minutes.
6. Stop the feed pump. Close the seawater intake and turn the yellow service valve to OFF. Drain the seawater strainer and the hose leading to the feed pump module. Disconnect the product tubing from the membrane housing and blow residual water out of the tubing. Empty the charcoal filter housing and flush water lines.

Your watermaker is now protected from biological growth and freezing for one year.



Service Valve OFF



Open the Pressure Relief Valve



48 Service hose connected and service valve to SERVICE



Connecting brine discharge service-hose

# Membrane Cleaning Procedures

*Spectra cleaning compound (SC-2 or SC-3) must be mixed with fresh water at a ratio of 1 container of compound to 3 gallons (12L) of unchlorinated water. An average of two gallons (8L) of water is already present inside a Ventura system, so this water must be figured into the mixture. A Ventura system requires one container of compound per cleaning.*

1. Turn the yellow service valve on the feed pump module to OFF (horizontal, see photo).
2. Push **Auto Store** to fresh water flush the system. Repeat, to flush the system twice.
3. Remove the cap on the service port on the feed pump module and install the inlet service hose from the service kit. Remove the quick disconnect fitting from the brine discharge outlet of the Clark Pump, and replace it with the quick disconnect brine discharge service hose. Lead both hoses into a 5 gallon (20 liter) bucket.
4. Push the **Auto Store** button and run the feed pump until one gallon of fresh water runs into the bucket from the brine discharge service hose. Stop the system.
5. Turn the yellow service valve to the SERVICE position.
6. **Make sure that the pressure relief valve on the Clark Pump is open (un-pressurized).**
7. Mix the cleaning chemical in the bucket. If possible, heat the solution to 120 deg. F (49 deg. C).
8. Start the system using the manual switch on the Spectra Connect control box. The intake service hose will draw solution from the bucket and the brine discharge service hose will return it. Circulate the solution through the system in this manner for 45 minutes.
9. Stop the pump. Replace the brine discharge overboard hose and run the pump until the bucket is empty. Stop the pump and turn the yellow service valve back to the RUN position. Restart the pump and run for 20 minutes to flush the chemicals out of the system (**DO NOT CLOSE the pressure relief valve!**)
10. Move the switch on the Spectra Connect Control Box to AUTO. The system may now be restarted, flushed, or stored.



Service valve in OFF position



Open the pressure relief valve!



Service hose connected and service valve to SERVICE



Attaching brine discharge service hose 49

# Suggested Spares for Ventura Connect

## Short term cruising, weekends etc.

Two treatments worth of preservative chemicals (either 2 bags of SC-1 or 2 gallons of Propylene Glycol). Three 5-micron filters, three 20-micron filters and a charcoal filter.

## Cruising 2 to 6 months at a time.

Four treatments worth of preservative chemicals (either 4 bags of SC-1 or 4 gallons of Propylene Glycol). Six 5-micron filters, Six 20-micron filters and two charcoal filters. One replacement feed pump head.

## Longer than 6 months

Additional filters, offshore cruising kit consisting of Clark Pump seals, O-rings, tools and membrane cleaning chemicals. One replacement strainer screen, replacement O-ring for strainer screen, and replacement O-rings for the filter housings. Spare feed pump or feed pump diaphragm.

### **Common Parts:**

<b>Item</b>	<b>Part Number</b>
SC-1 STORAGE CHEMICAL	KIT-CHEM-SC1
SC-2 CLEANER	KIT-CHEM-SC2
SC-3 CLEANER	KIT-CHEM-SC3
BASIC CRUISE B	KIT-BCK-B
OFFSHORE REBUILD KIT	KIT-OFFSH
5 MICRON FILTER	FT-FTC-5
20 MICRON FILTER	FT-FTC-20
CHARCOAL FILTER	FT-FTC-CC
5" STRAINER SCREEN	FT-STN-5S
OIL/WATER FILTER	FT-FTC-OW
FEED PUMP	EL-FP-12V or 24V
FEED PUMP HEAD	PL-PMP-SFPH
FEED PUMP DIAPHRAGM	EL-FP-DP
5" STRAINER O-RING	SO-STN-5SS
FILTER HOUSING O-RING	SO-FHS-10H
SALINITY PROBE	EL-MPC-SP4
CHARCOAL FILTER HOUSING O-RING	SO-FHS-3PCS10

# Troubleshooting Ventura Connect Systems

SYMPTOMS	PROBABLE CAUSE	REMEDY
Feed pump runs constantly, will not turn off	<ul style="list-style-type: none"> <li>Manual switch in ON position on control box</li> </ul>	<ul style="list-style-type: none"> <li>Turn off manual switch on control box</li> </ul>
Feed pump runs with loud noise	<ul style="list-style-type: none"> <li>Intake blocked</li> <li>Air in system</li> </ul>	<ul style="list-style-type: none"> <li>Check thru-hull valve</li> <li>Check sea strainer for leaks</li> <li>Check fresh water flush module for leaks</li> <li>Re-prime system (restart)</li> </ul>
No lights or display, system does not operate	<ul style="list-style-type: none"> <li>Remote display not connected</li> </ul>	<ul style="list-style-type: none"> <li>Check display cable connections at back of display and at control box</li> <li>Check and reset main DC supply breaker</li> <li>Check for voltage (12 or 24 VDC) at control box power input studs</li> <li>Try manual switch on Spectra Connect control box: If pump runs, then control or display is defective</li> </ul>
Pump runs intermittently, cycling on/off	<ul style="list-style-type: none"> <li>Overpressure switch on ShurFlo pump opening</li> </ul>	<ul style="list-style-type: none"> <li>Adjust or replace switch (see page 58)</li> </ul>
Display activates, but pump will not run	<ul style="list-style-type: none"> <li>Loose or broken pump wire connection</li> <li>Tanks are full (if equipped with tank switch)</li> </ul>	<ul style="list-style-type: none"> <li>Check wiring at terminal block inside Spectra Connect</li> <li>Check tanks—system cannot be started if tanks are full.</li> </ul>
System runs, no product water delivered to water tanks, GPH bar graph shows OK, “Good” LED activated	<ul style="list-style-type: none"> <li>Diversion valve inoperative or wiring fault.</li> <li>Disconnected or broken product tubing</li> <li>Diversion valve plunger stuck</li> </ul>	<ul style="list-style-type: none"> <li>Check wiring at diversion valve and inside control box</li> <li>Check product tubing</li> <li>Disassemble and clean diversion valve plunger or replace valve (contact factory)</li> </ul>
System runs, no product water delivered to water tanks, GPH bar graph shows OK, “reject” LED activated	<ul style="list-style-type: none"> <li>High salinity of product water, causing system to reject water</li> <li>Salinity probe out of calibration or defective, bad cable</li> <li>Chlorine damage to membranes</li> <li>Pressure relief valve open</li> </ul>	<ul style="list-style-type: none"> <li>Check for low feed pressure</li> <li>Check for leaks at high pressure hoses</li> <li>Test product water with hand-held tester— if over 500 PPM for 1 hour, contact factory</li> <li>Close pressure relief valve</li> </ul>

# Ventura Connect Fault Alarms

SYMPTOMS	PROBABLE CAUSE	REMEDY
<p>“System Stalled”            (“system stalled” may alarm when using the control panel to run system for servicing with the pressure relief valve open– use manual override switch instead)</p>	<ul style="list-style-type: none"> <li>• Pressure relief valve open</li> <li>• Intake thru-hull closed</li> <li>• Airlocked system</li> <li>• No signal from Product Flow Sensor</li> </ul>	<ul style="list-style-type: none"> <li>• Close pressure relief valve</li> <li>• Check thru-hull</li> <li>• Purge air</li> <li>• Clean or replace Product flow sensor meter</li> </ul>
<p>“High Pressure”</p>	<ul style="list-style-type: none"> <li>• Blocked brine discharge</li> <li>• Fouled membrane</li> </ul>	<ul style="list-style-type: none"> <li>• Check brine discharge</li> <li>• Clean membrane</li> </ul>
<p>“Voltage Too High”            “Voltage Too Low”</p>	<ul style="list-style-type: none"> <li>• Battery voltage too high or low</li> <li>• Loose wires or poor connections</li> </ul>	<ul style="list-style-type: none"> <li>• Charge batteries</li> <li>• Check charging voltage</li> <li>• Check power connections</li> </ul>
<p>“Re-starting”</p>	<ul style="list-style-type: none"> <li>• No signal from Product Flow Sensor at startup.</li> <li>• System stalled</li> </ul>	<ul style="list-style-type: none"> <li>• See remedy above for “system stalled”</li> </ul>
<p>“Check Fuse” (followed by fuse number)</p>	<ul style="list-style-type: none"> <li>• Blown fuse at circuit board</li> </ul>	<ul style="list-style-type: none"> <li>• Replace fuse (mini automotive type ATM). See page 82.</li> <li>• Look for cause</li> </ul>
<p>“Service Prefilter”</p>	<ul style="list-style-type: none"> <li>• Clogged filters</li> <li>• Loose or defective pressure sensor wires</li> </ul>	<ul style="list-style-type: none"> <li>• Install new filters</li> <li>• Check sensor wiring</li> <li>• With clean filters, recalibrate Clean Pressure</li> </ul>
<p>“Salinity High”</p>	<ul style="list-style-type: none"> <li>• High product water salinity</li> <li>• Chlorine damage to membranes</li> <li>• Defective salinity probe or cable, cable disconnected</li> </ul>	<ul style="list-style-type: none"> <li>• Check for low feed pressure</li> <li>• Check for leaks at high pressure hoses</li> <li>• Remove and clean probe contacts. Check calibration</li> <li>• Check cable connections</li> <li>• Clean membrane</li> </ul>



## Alarm Override and Manual Operation

**In the event of a sensor failure** resulting in a shut down due to a false alarm, the failed sensor can be overridden. High Pressure, Service Prefilter, System Stalled (airlock), and Salinity Probe issues can all be overridden and the system will still run automatically with all other functions intact. **Be absolutely certain that the alarm is false before overriding the automatic controls.**

**In the event of complete Spectra Connect control failure**, the system may be operated manually as follows:

- Switch on the feed pump by turning the toggle switch to RUN MAN. The automatic safety controls are disabled in manual mode. Shut the unit down if the Clark pump does not cycle, if air is continuously present in the intake line, or if the feed pump is excessively noisy.
- Always discard the product water for the first few minutes of operation as the initial product water may not be potable. Take a water sample by loosening the 1/4-inch product tube fitting at either the feed pump module or the membrane outlet. Check it with a handheld salinity meter or taste it.
- The diversion valve is an electrically operated three-way valve, which is normally energized by the Spectra Connect controls in order to send water to the tank. It will not open automatically in manual mode, and must be opened using the mechanical override button. **The button is located on the side closest to the Clark pump cylinder.** Push the manual override button in and rotate 1/4 turn clockwise to open the valve.



**Figure 1: Manual Operation**

## Ventura Flow Test

The flow test is the most useful diagnostic test for system performance, and should be done before replacing or cleaning your membrane. Changes in production or water quality are normally caused by something **other than** the membrane, unless the system has been left unused for a long time.

Before the flow test, change all filters and clean the sea strainer. Carefully check for water or air leaks, as air in the system will cause low production and erratic salinity. Look for air bubbles in the Product Flow Sensor, feed water hoses, and brine overboard hose.

Run the system and watch the feed pressure very closely. If the feed pressure to the Clark Pump is asymmetrical from one stroke to another, this could be part of the problem. **A difference of a few PSI is acceptable, but anything over that is an issue.** If the pump is asymmetrical, Clark Pump repairs should be done before continuing with these tests.

If no asymmetry is noted, continue with this test.

Make sure the ShurFlo overpressure cutout switch (PL-PMP-SFPH) is set to 125 PSI. With the pump running, close the brine discharge thru-hull or kink the brine discharge hose. The feed pressure should rise to 125 PSI, then the pump should shut off. If the pump shuts off at a lower pressure see Adjust ShurFlo Pressure Switch on page 45.

You will need a graduated bucket, either a graduated pitcher or large measuring cup, and a stopwatch. Before the flow test, change all filters and clean the sea strainer. Log the voltage at the feed pump at the same time. Confirm at least 12.5 Volts at the feed pump on 12-Volt DC systems; 25 volts on 24-Volt DC systems.

Take two measurements and compare them with the table on the following page. The first measurement is the product flow alone. The second is the product flow combined with the brine discharge flow to get the **total flow or feed flow**. You may take these measurements by two methods:

1. Time the product flow into a graduated pitcher, then divert both the product flow and brine discharge together into a bucket to measure total flow.

OR

2. Divert the product flow into the pitcher while diverting the brine discharge into the bucket. Time the flow of both. After calculating the product flow, pour the pitcher of product into the bucket of brine to measure total flow.

**The ratio of product flow to total flow gives us our recovery rate, as a percentage. If the percentage is below the minimum it indicates an internal leak in the Clark Pump.**

**1. Product Flow:** Product flow is expressed in Gallons Per Hour (GPH) or Liters Per Hour (LPH), by this equation:

$3600 \div \text{time in seconds} \times \text{quantity of water in gallons or liters} = \text{GPH or LPH}$   
 There are 3600 seconds in an hour.

Example: It took 3 minutes and 35 seconds to collect 1 gallon of product water.

$3600 \div 215 \times 1 = \mathbf{16.74 \text{ GPH}}$  (3 minutes, 35 seconds is 215 seconds)

Example: It took 2 minutes and 25 seconds to collect 2.5 liters of product water.

$3600 \div 145 \times 2.5 = \mathbf{62.07 \text{ LPH}}$  (2 minutes, 25 seconds is 145 seconds)

**2. Total Flow or Feed Flow:** Feed flow or total flow (brine + product) is expressed in Gallons Per Minute (GPM) or Liters Per Minute (LPM), by this equation:

$60 \div \text{time in seconds} \times \text{quantity of water in gallons or liters} = \text{GPM or LPM}$

Example: It took 1 minute and thirty-seven seconds to collect 5 gallons of total flow.

$60 \div 97 \times 5 = \mathbf{3.09 \text{ GPM}}$  (1 minute, 37 seconds is 97 seconds)

Example: It took 53 seconds to collect 12 liters of total flow.

$60 \div 53 \times 12 = \mathbf{13.58 \text{ LPM}}$

**3. Recovery Rate:** Product Flow  $\div$  Total Flow = Recovery Rate %

Example:  $\frac{6.5 \text{ GPH product flow}}{1.7 \text{ GPM total flow} \times 60} = \mathbf{.063 \text{ or } 6.3\%}$

(you must first multiply total flow by 60 to convert from GPM to GPH)

System	Feed		Static * Pres- sure	Feed Flow				Product Flow			
	Pres- sure			Flow		MIN	MIN	Flow	Flow	MIN	MIN
	psi	bar		psi	gpm	lpm	gpm	lpm	gph	lph	gph
Ventura	60-70	4.2-5	10-15	1.7	6.4	1.65	6.2	6.5	24.6	5.7	21.5
VT 200	80-90	5.6- 6.3	20-25	1.7	6.4	1.6	6.0	8.3	31.4	7.7	29.1

**For Spec Production:**

12V Systems: Run at 13.2 VDC min

24V Systems run at 26.4 VDC min

**\*pressure relief valve open ½ turn**

In order to make good quality product water, you need the proper amount of feed water flow, as in the table above. Compare the product flow to the total feed flow. Product flow should be 6.5% minimum 5.5%) of total flow for a Ventura 150, and 9% (minimum 8%) of total flow for a Ventura 200T. If product percentage is low, you may have an internal leak in the Clark Pump.

For every  $\frac{1}{10}$ <sup>th</sup> of a GPM feed water flow loss, we will lose about  $\frac{1}{2}$  gallon per hour of product flow and the salinity will go up 100 PPM.

Low feed flow combined with low system pressures is most frequently caused by a worn Shurflo pump head (PL-PMP-SFPH).

## Poor Product Water Quality

With any product water quality issue, you must ensure accurate calibration if you are using a salinity meter. For general quality evaluation, your taste is always good enough.

Membranes are not an exact science and two identical systems can have different product quality. World health standards deem water of up to 1000 PPM of total dissolved solids acceptable for drinking. We consider anything below 750 PPM acceptable but not ideal, and anything below 500 PPM excellent. Factors that could affect water quality are addressed below.

**LOW SYSTEM FLOW OR PRESSURE** will equate to lower product quality (higher PPM).

Ventura systems, which have a higher feed to output pressure ratio (See nominal pressures under Flow Test, page 55), as well as a higher feed flow/membrane area ratio, will produce water in the 150-200 PPM range.

**DAMAGE TO THE MEMBRANE** by chlorine contamination. Flushing the system with chlorinated water will irreparably damage the membrane. Charcoal filters are used to absorb any chlorine which might be present in flush water. They must be of proper specification to be suitable. See page 56. There is no test for chlorine damage except the process of elimination of other causes.

**DIRTY OR SCALED** membranes. A dirty (foreign material), scaled (mineral deposits), or contaminated (bacterial growth) membrane can result in poor water quality and abnormal operating pressures. If operating pressures are above normal, then cleaning is indicated. If the system pressures are within operating normal range, cleaning may have little result. Avoid cleaning as a diagnostic tool. Low water quality after storage with propylene glycol can usually be remedied by extended flushing or an SC-2 cleaning. (See pages 44-45 and 48.)

**MECHANICAL LEAKAGE** within the membrane pressure vessel. This is an unlikely but possible cause of poor water quality. A pinched or damaged O-ring within the pressure vessel, a scratch on the product tube on the membrane, a scratch within one of the end caps, or a seal fouled by contamination could allow sea water into the product water.

If system flow (product plus brine) is 1.5 GPM or above, the membrane is clean, the product flows are consistent with the system flow and the water quality is still not acceptable, then replacement of the membrane is indicated.

## Technical Bulletins

The following pages include Spectra's most commonly-used technical bulletins, covering tests, adjustments, troubleshooting, and common points of confusion. Many more technical bulletins are available on the Spectra website, [support.katadyngroup.com](http://support.katadyngroup.com).

### ACCUMULATOR PRESSURE

Your Spectra watermaker is supplied with a pressure accumulator tank (PL-ACC-TK), which should be installed in the feed water line between the prefilters and the Clark Pump.

The purpose of the feed line accumulator is to reduce the spikes in the feed pressure caused by the cycling of the Clark Pump. If the accumulator is not properly charged it can lead to problems with the Shurflo Pump pressure cutout switch (see page 58). The accumulator has a Schrader air valve, like a car tire, which allows the internal air bladder of the accumulator to be pre-charged. The accumulator should be pumped up to about 65 psi (4.5 bar) for best results. Add air using a tire pump or air compressor. You can experiment with the exact pressure that will give the best pulsation dampening on your installation.

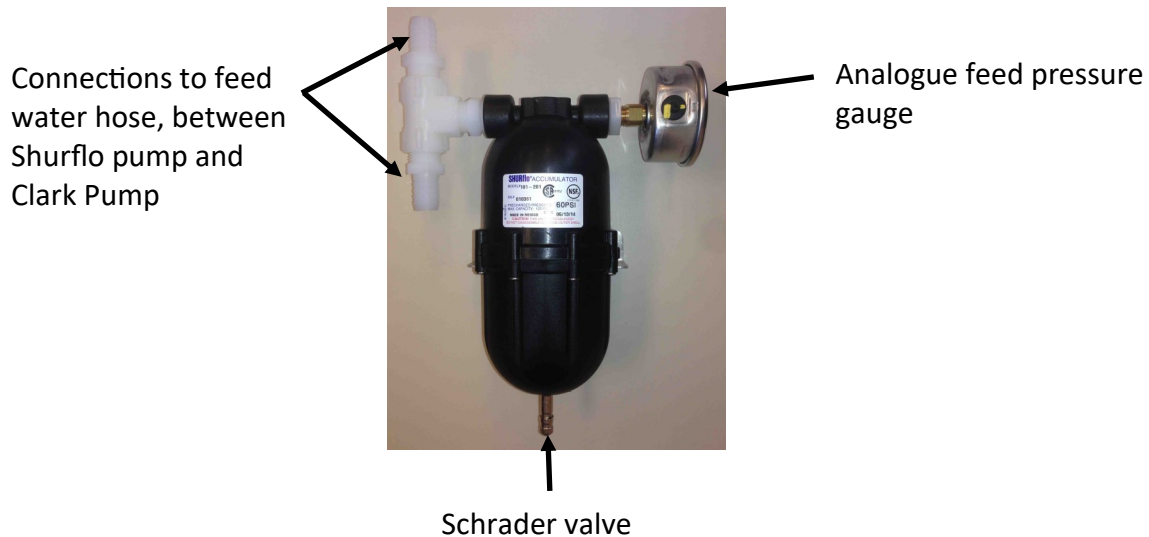

# PREFILTERS

**It is important to remember that your Spectra Watermaker is designed to process clean, open-ocean seawater. Any departure from that standard for your seawater intake runs the risk of causing excessive wear or damage to internal pump parts and/or the vulnerable reverse osmosis membrane.** Additional prefiltration considerations and/or extremely frequent prefilter replacements may be required in any deviation from open-ocean seawater. Your local service provider or installer may have specific recommendations based on their experience with water conditions unique to your region.

Observe the seawater around your vessel. Is it clean enough to use for your seawater intake? There are several things to avoid feeding to your watermaker:

- *petroleum products, such as oil, fuel, thinners, paints, paint removers, etc.*
- *chlorine-treated water; e.g., most “dock” water*
- *silty water — water contaminated by fine, hard, suspended particulates*
- *putrid water, “red tides”, or any seawater that smells or looks contaminated*
- *harbor/marina water that you cannot see through or that shows visible signs of contaminate (neighboring boats docked nearby may be discharging contamination! Sewage, chemicals, etc.)*

Judging the quality of seawater input always involves a certain calculated risk. We know of watermaker systems that have been destroyed far offshore by intaking fresh whale excrement or oil contaminants from natural seepages. The chance of such things happening is normally small but should be considered. On the other hand, **regularly running a watermaker in an enclosed marina or harbor runs a much higher risk of harmful contamination.** If you need to test a new installation while in a marina or harbor, monitor the water quality around your vessel carefully while testing. Often times you should be able to run the watermaker safely for enough time to briefly check out the system if you are mindful of external feed conditions. If this is not possible, an artificial ocean is a useful alternative (see Page 30 for artificial ocean testing/instructions). Don't sail away without testing a new installation or repair!

During normal operation, the feed water is filtered in two stages. First it passes through a fine mesh metal sea strainer, which protects the feed pump from foreign materials and sea creatures. After passing through the feed pump, the feed water passes the filter housings containing 20 and 5 micron elements, removing very fine particles that could damage the Clark Pump and shorten membrane life. An additional carbon filter prevents the entrance of chlorine during fresh water flushing (see next page).

Prefilter maintenance schedules will vary widely depending on how and where the system is used. If large amounts of feed water are run through the system over a relatively short period of time in biologically fertile near-shore waters, the prefilters will plug up, water production and quality will drop, and the system pressure will change dramatically. In blue water conditions the prefilters may only need to be changed every week or two.

When operated for only an hour or two a day in inland or near-shore waters, the trapped plankton will begin to decay in the filters long before the elements plug up. The decaying plankton and bacteria will cause a rotten egg smell in the product water. This decay will set in overnight in tropical waters, or after a week or two in higher latitudes

## PREFILTERS CONT.

Our filter element part numbers are FT-FTC-XX, where the last digits indicate the micron rating. FT-FTC-5 is for a 5 micron element, FT-FTC-20 is a 20 micron element. The optional oil/water separator is FT-FTC-OW.

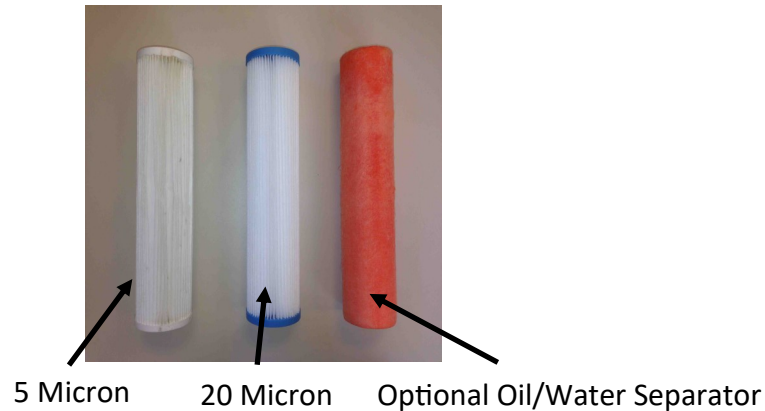

## CHARCOAL FILTERS

The charcoal filter element (FT-FTC-CC) removes chlorine from the fresh water flush water supply, as the RO membrane can only handle small amounts of chlorine without permanent damage.

The charcoal filter used for the fresh water flush system will not plug up unless you have very dirty domestic water in your boat's supply tank.

The charcoal filter we supply removes 99.7% of the chlorine. Beware when buying other charcoal filters. If they don't specify the percentage of chlorine removed, don't use them. Cheap ones may remove only 60% or 70%. Also, there are aftermarket filters which are very close to, but not exactly, the right dimensions, and they will not seal in the housing. If you skimp on the charcoal filter you risk damaging a \$600.00 membrane on the first flush. The other factor is the flow rate that the filter can handle. Because the chlorine is adsorbed by the charcoal, it must remain in contact with the charcoal for a sufficient period of time for all of the chlorine molecules to be captured. The filters we use can handle 1.5 gallons (6 liters) per minute flow, and are good for 3000 gallons (12,000 liters) at 1.5 GPM, or six months, whichever comes first. Regardless of the amount of water treated, the charcoal loses its effectiveness after six months.



Charcoal filter, Spectra part number FT-FTC-CC

## SHURFLO PUMP WON'T RUN

If the pump has power to it but the pump won't run, first check the pressure switch. The pressure switch (EL-FP-PS) is located on the wet end of the pump and has two red wires plugged into it (see photo, next page). Jump the two red wires together and see if the pump runs. You can safely run the system with the pressure switch jumped, just keep an eye on the feed pressure and don't let system pressure exceed 110 PSI. Replace the switch when a spare is available. The pressure switch should never open unless there is a problem with the system or it is incorrectly adjusted. See Adjust Shurflo Pressure Switch on next page.

If the pump will not run with the pressure switch jumped then it is most likely a problem with the brushes or overheat protection switch inside the motor. The motor will come completely apart by removing the two screws on the end of the motor. Remove the rear cover and paper insulator. Pull out the plastic brush holder. The thermal switch is located on one of the brush leads. With an ohmmeter, check for continuity through the switch. If it is open, you can make temporary repairs by wiring around it, being careful that your new wiring doesn't chafe on the moving parts, nor resist the springs that push the brushes on to the commutator. The overheat switch is unlikely to fail unless the motor has overheated. Consider relocating the pump or improving ventilation if the overheat protection has failed.

If any corrosion is apparent the brushes may be sticking. Once apart clean all the carbon dust from all the parts. Clean the commutator with light sandpaper. Make sure to clean the small grooves on the commutator with a small sharp tool to remove the carbon in between the segments. Adjust the springs on the brush holders so the brushes slide smoothly in and out. If the bearings are rough and binding, remove the rubber dust cover to clean them, grease them, and work them free by hand. Don't service the bearing unless absolutely necessary. Reassemble in reverse order. You can hold the carbon brushes back with papers clips inserted through the slots in the brush holder so they don't hang up on the bearing during assembly. Make sure the corrugated bearing shim doesn't push out. If it does, push it back into place.



## ADJUST SHURFLO PRESSURE SWITCH

Shurflo feed pumps are equipped with a high pressure cutout switch (EL-FP-PS). This is the small black unit on the end of the wet end of the pump head (PL-PMP-SFPH) where the two red wires connect. If the pressure switch is not properly adjusted the pump may cut out each time the Clark pump cycles and the feed pressure spikes. When this happens the production will drop and salinity will increase. The points in the switch will fail quickly if set too low because of the constant arcing each time the Clark Pump shifts.

On the very center of the switch is a small 5/64" Allen screw. While running the system close the brine discharge seacock or kink the discharge hose, to block the flow. Watch the pressure gauge and adjust the pressure switch to shut off at 125 psi. Turn the Allen screw clockwise to increase the cut off set point.

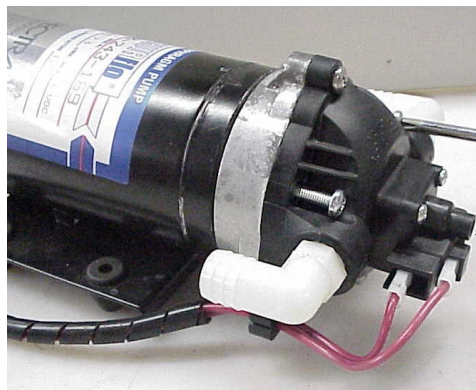

Pressure Switch  
Adjusting Screw

# Spectra Connect Settings

Your new Spectra Connect is designed to make your watermaker easier than ever to operate, maintain and enjoy. This section will guide you through some of the more advanced settings options available.

**Always use caution when changing any factory default settings, as serious damage can occur.**



The Spectra Connect automatically monitors the operation of the system to ensure a long and trouble-free service life. If an operating parameter changes, the Connect can switch operating modes, shut itself down, or automatically store itself in order to protect your watermaker.

It includes advanced calibration sequences to make proper setup and maintenance of your watermaker easier than ever.

The onboard time clock feature allows for temporary power interruptions without detrimental effects on the system. In some cases your watermaker will continue to function in its last known operating state.

The Spectra Connect has built in data logging, allowing for easy access to historical operating data—which can indicate a wearing component or spares to be carried along before a failure occurs.

Built in warnings for preventative maintenance automatically alert a user of pending maintenance items, helping to keep your watermaker's up-time to 100%! Advance warnings are pre-programmed for Prefilter Life, Clark Pump rebuilds, feed pump heads, membranes, Z-Ion reactor rod life, and carbon filter life. These warnings are resettable, allowing you to perform the maintenance before a catastrophic failure, then reset the interval—so you're always on top of the maintenance cycle!

## Spectra Connect Settings - Cont.

### User Settings

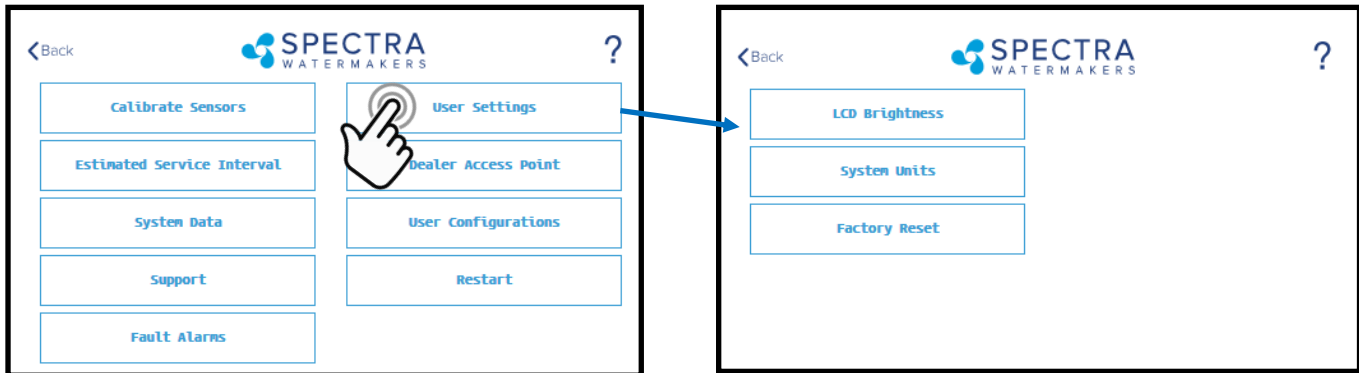

**LCD Brightness:** Set brightness of the hardwired display(s) from 10—100%

**System Units:** Change from US Standard units to Metric

**Factory Reset:** Resets any changed parameters a user has made back to the factory defaults for that configuration.

### Fault Alarms

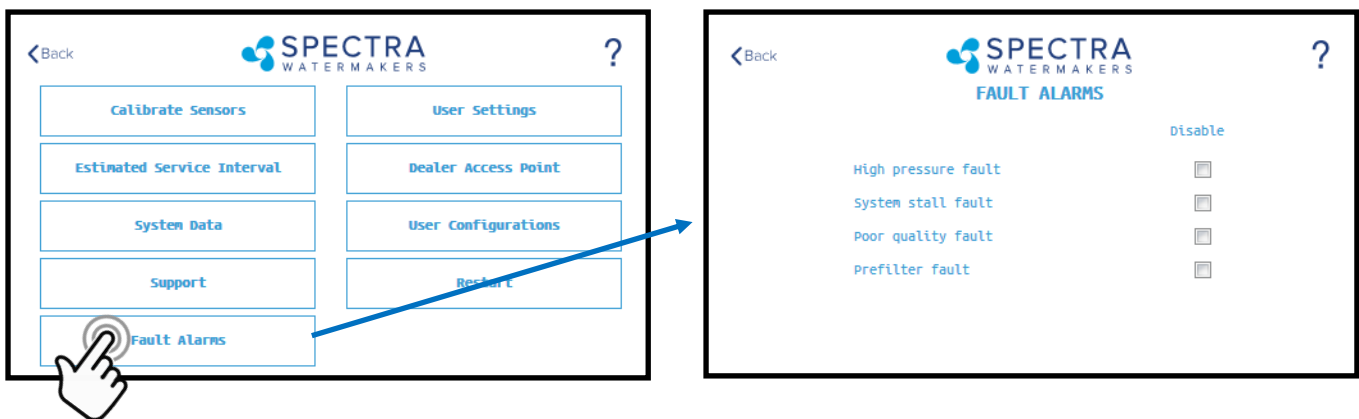

**CAUTION!!** Never disable a Fault Alarm without being certain that the issue is with a bad sensor. Disabling a fault and running the system can cause serious damage or injury.

**High Pressure Fault:** Disables the 'High Pressure' shutdown fault in the event of a feed pressure sensor failure.

**System Stall Fault:** Disables the 'System Stalled' shutdown fault in the event of a failed product flow sensor. System stalled alarms occur when the control board does not sense any product water being produced, and shuts down to protect the pump from running dry.

**Poor Quality Fault:** Disables the 'High Salinity' shut down fault in the event that the salinity probe has failed or cannot be calibrated within range. **NOTE: The diversion valve will always be active when this fault is disabled. ALWAYS VERIFY PRODUCT QUALITY BEFORE DRINKING. Serious health risks may occur.**

**Prefilter Fault:** Disables the 'Service Prefilter' shut down fault in the event that the boost pressure sensor has failed or cannot be calibrate within range. **CAUTION: Permanent damage to the feed pump can occur if this fault is disabled, use caution when operating this system with this fault disabled.**

# Settings - Cont.

## Dealer Access Settings

It is highly recommended that users consult with a factory trained technician before altering any settings behind the 'Dealer Access Point'. **Changing this settings without understanding the full effect of each change can void the warranty of your system, and cause irreparable damage.**

**If any settings are inadvertently changed, they can be reverted back to the defaults by using the 'Factory Reset' feature.**

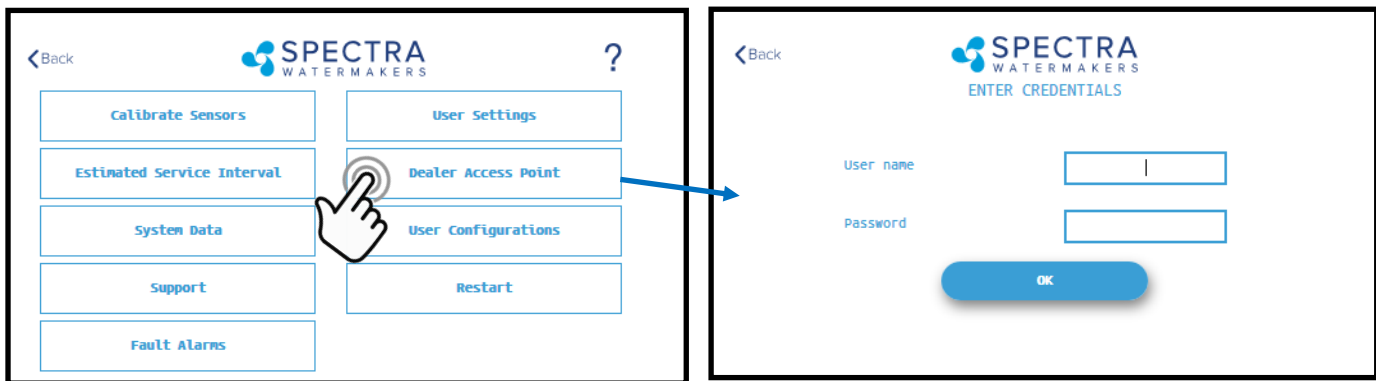

Default Login: admin

Default Password: admin

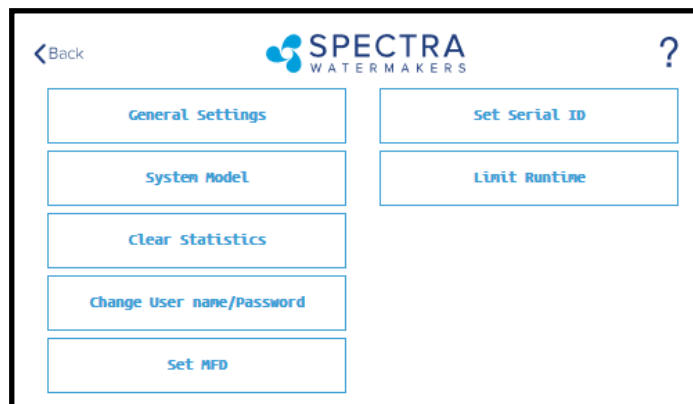

**System Model:** Configures the Spectra Connect for a different system model from a preset list of options.

**Clear Statistics:** Resets all of the Estimated Maintenance Intervals back to 100%. This feature should only be used on a brand new system.

**Change Username/password:** Changes the default username and password. If you forget your changed username and password, a Factory Reset will revert back to the default username and password.

**Set MFD:** Changes the Manufactured Date on the system. This should only be adjusted if a control board is being replaced on an older system.

**Set Serial ID:** Changes the Serial Number recorded in the Spectra Connect. This should only be adjusted if a control board is being replaced on an older system.

**Limit Runtime:** Limits the maximum run time for the system before shutting down and fresh water flushing. Disabling this setting allows the watermaker to be operated 24/7.

# Settings - Cont.

## Dealer Access Settings

It is highly recommended that users consult with a factory trained technician before altering any settings behind the 'Dealer Access Point'. **Changing this settings without understanding the full effect of each change can void the warranty of your system, and cause irreparable damage.**

If any settings are inadvertently changed, they can be reverted back to the defaults by using the 'Factory Reset' feature.

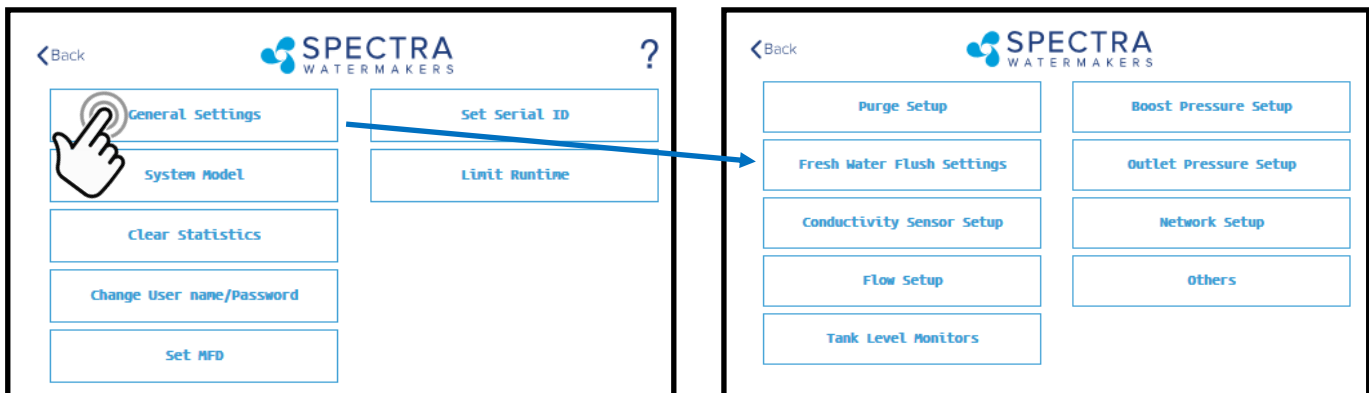

**Purge Setup:** Adjusts the time and maximum feed pressure allowed for the Purge Mode. **CAUTION: Permanent damage to the membrane can occur if this setting is adjusted. Consult the factory before making any adjustments.**

**Fresh Water Flush Settings:** Allows adjustment of the fresh water flush duration and the interval between flushes. If the Z-Ion is installed, the Flush Interval should be changed to 30 days.

**Conductivity Setup:** Allows for enabling or disabling conductivity sensors on the feed water and product water. Set the threshold for the diversion valve to divert water to the tanks.

**Flow Setup:** Allows the user to adjust the flow sensor settings, or disable a flow sensor circuit altogether. **DO NOT USE THIS SETTING TO CALIBRATE THE PRODUCT FLOW.** Follow instructions on calibrating the flow sensor in this manual.

**Tank Level Monitors:** Enable and disable the Tank Level Sensors, which read the % remaining in the tank, and the tank switches, which allow the system to turn on/off automatically.

**Boost Pressure Setup:** Enable alternate Boost Pressure sensors, change the Low Vacuum Limit, or Boost Pressure Setpoint. **CAUTION: Permanent damage to the pump can occur if this setting is adjusted. Consult the factory before making any adjustments.**

**Low Vacuum Limit:** The minimum boost pressure required at the inlet to the pump. This setting prevents the pump from getting damaged by running under high vacuum. Adjusting it to a lower number increases the risk that the pump will suffer damage during normal operation.

**Boost Pressure Setpoint:** During startup the controller turns on the boost pump and waits for the Boost Pressure to reach the Boost Pressure Setpoint. If the boost pressure fails to reach this setpoint, then the main pump won't turn on. Reducing the Boost Pressure Setpoint may cause the system to start, then immediately shut down due to low boost pressure.

**Outlet Pressure Setup:** Set High Pressure Limit, enable alternate high pressure sensors, select pressure sensor scaling. **CAUTION: Permanent damage to the pump can occur if this setting is adjusted. Consult the factory before making any adjustments.**

**Network Setup:** Enabling the Spectra Connect Wireless access turns on a Power Over Ethernet feature on the wired connection. **ENABLING THIS FEATURE CAN CAUSE SERIOUS DAMAGE TO YOUR SHIP'S NETWORK. DO NOT ENABLE THIS FEATURE WITHOUT CONSULTING A QUALIFIED TECHNICIAN OR THE FACTORY.**

# Settings - Cont.

## Dealer Access Settings

It is highly recommended that users consult with a factory trained technician before altering any settings behind the 'Dealer Access Point'. **Changing this settings without understanding the full effect of each change can void the warranty of your system, and cause irreparable damage.**

If any settings are inadvertently changed, they can be reverted back to the defaults by using the 'Factory Reset' feature.

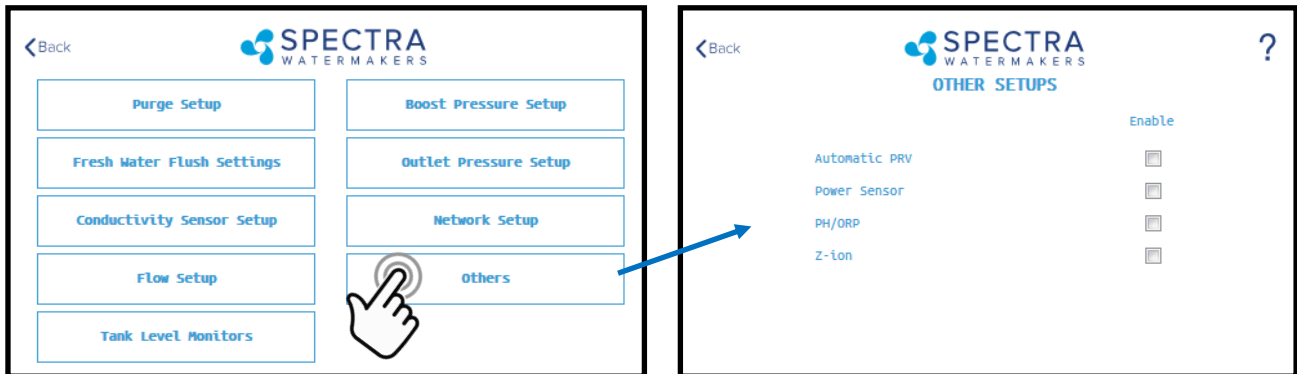

**Automatic PRV:** Enables an optional Automatic Pressure Relief Valve, after it is installed. This setting should remain off unless you are certain that you have this feature installed on your system.

**Power Sensor:** Enables or disables an optional power sensor, after it is installed.

**PH/ORP:** Enables an optional pH or ORP meter, after it is installed.

**Z-Ion:** Enables or Disables the optional Z-Ion system, after it is installed. If the Z-Ion is enabled, you should also adjust the Flush Interval to 30 days.

## Tank Level Monitors

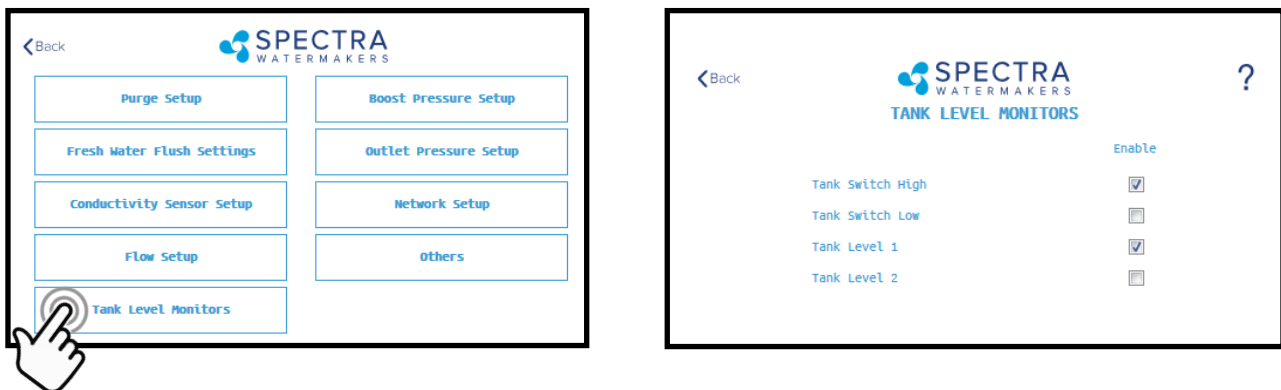

**Tank Setup** - Enable/disable tank sensors.

**Enable Tank Switch High** - Enable/disable tank switch high. If this is disabled Auto Fill and Fill Tank run modes will not be available.

**Enable Tank Switch Low** - Enable/disable tank switch low. If this is disabled Auto Fill mode will not be available. Both High and Low tank switches must be enabled for Auto Fill mode.

**Enable Tank Level 1** - Enable/disable tank level sensor 1. If this is disabled there will be no tank level reading and tank level gauge will read "!".

**Enable Tank Level 2** - Enable/disable tank level sensor 2..

# Fault Handling

Faults are hazardous conditions that might occur during running of your watermaker. The control board has the ability to monitor these faults in real time and take necessary actions to prevent damaging your equipment.

## HIGH PRESSURE FAULT

High pressure fault is triggered if

Outlet pressure (Feed/Membrane pressure) > Pressure Limit

If a high pressure fault is triggered, the system goes to low production mode if it is running in high production mode, or stops the operation if it is already running in low production mode. Then the system will begin the Auto Store mode.

### Resolutions

Check for kinked or blocked hoses.

Confirm “#3 Sensor PSI High limit” and “#3 Sensor PSI Offset” options on Outlet Settings.

Clean membrane.

## SYSTEM STALL FAULT

System stall fault is triggered if

There is no product flow for 1 minute continuously.

If system stall fault is triggered, machine will stop the current run cycle and will prompt to restart. If restarted it will retry the previous running mode. If the stall condition persists even after restart, the system will begin the Auto Store mode.

### Resolutions

Confirm product water at membrane endcap.

Check intake line for restrictions, blockages or air leaks.

Close Pressure Relief Valve on Pump.

Confirm controller settings correct.

## SERVICE PREFILTER FAULT

The Service Prefilter fault is triggered if

Filter reading between the two sensors has a difference greater than 10 psi.

### Resolutions

Change prefilters.

Check sensor for proper operation

Unplug and unscrew sensor. Gently check for gunk or debris with paper clip or wire.

## POOR QUALITY FAULT

The High Salinity fault triggers if

The Salinity of the product water is above the threshold (measured salinity > Salinity 1 threshold) for more than 8 minutes.

If the High Salinity fault is triggered, the machine will stop the current run cycle and will prompt to restart. If restarted it will retry the previous running mode. If the High Salinity fault condition persists even after restart, the system will begin the Auto Store mode.

### Resolutions

Check pump operation - Clark Pump (pressure relief valve closed), Feed Pump (moving water).

Confirm product water quality.

Membrane damage - clean or replace.

Salinity probe out of calibration.





Clean or replace salinity probe.









# Ventura 150C-200C-T Electrical Specifications





## Ventura 150C 12V:

-  **Power Supply Voltage: 12 VDC**
-  **Bench Test: 14 V / 9.4 A**
-  **Power Consumption: 132 W**
-  **Efficiency: 20.5 Wh/gal**





## Ventura 150C 24V:

-  **Power Supply Voltage: 24 VDC**
-  **Bench Test: 27.2 V / 4.3 A**
-  **Power Consumption: 117 W**
-  **Efficiency: 17.5 Wh/gal**

## Ventura 200C 12V:

-  **Power Supply Voltage: 12 VDC**
-  **Bench Test: 14 V / 10.2 A**
-  **Power Consumption: 143 W**
-  **Efficiency: 17.2 Wh/gal**

## Ventura 200C 24V:

-  **Power Supply Voltage: 24 VDC**
-  **Bench Test: 26.2 V / 10.5 A**
-  **Power Consumption: 275 W**
-  **Efficiency: 35.7 Wh/gal**

# **Exploded Views & Part Numbers**



# Parts I.D.

## (Top View)



Pump to Pressure Vessel  
Lower SS Tube:  
**PL-TB-HPTPVLS**

3/8" NPT x 3/8" Tube Fitting JG  
**PL-MTS-3/8x3/8J**

Rubber Mount  
**HD-RBP-RM**  
Plastic Spacer  
**HD-SPN-MKINS**

Pump to Pressure Vessel  
Upper SS Tube:  
**PL-TB-HP-HPTVUS**

Nickel-Bronze High Pressure  
Elbow  
**PL-MTE-3/4S1/2B**

## Rear View

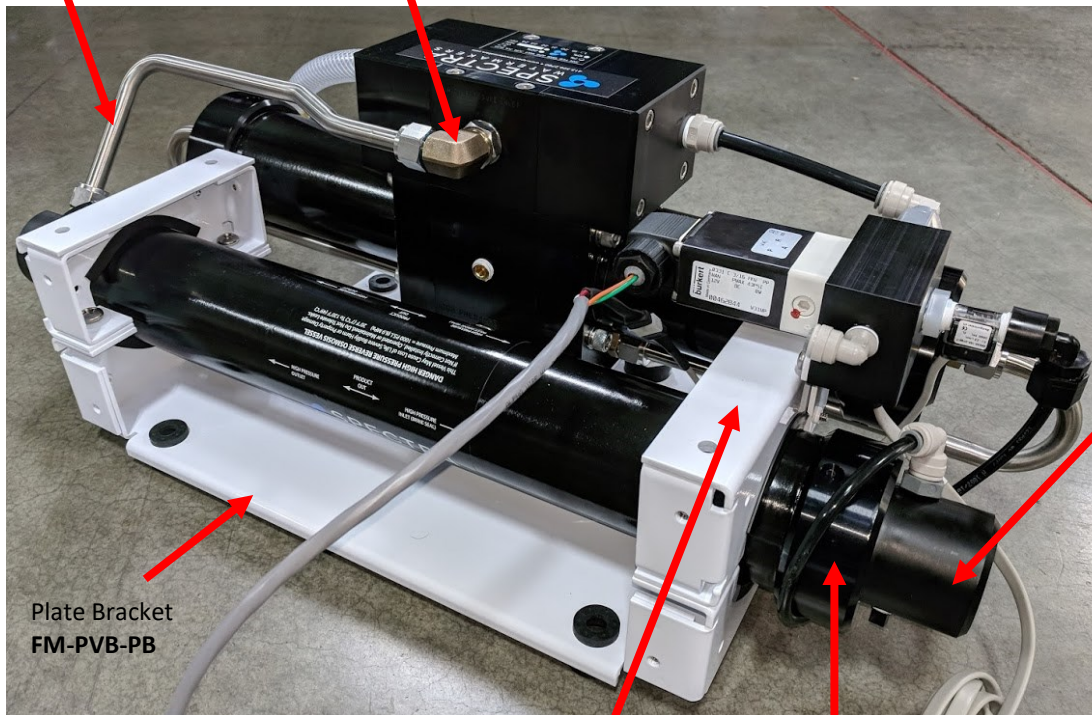

Pressure Vessel End Cap  
**KIT-PV-25EP1**

Plate Bracket  
**FM-PVB-PB**

Plate Bracket End Cap  
**FM-PVB-PBE**

Pressure Vessel End Ring  
**FT-PV-ER**

# Parts I.D.



**SUB-CT-Z-HPILHA**  
CT 340R Quick Disconnect

3/8" NPT X 5/8" Hose Barb El.  
**PL-HBE-3/8X5/8**

3/4" NPT X 5/8 Hose Barb El.  
**PL-HBE-3/4X5/8**

Pressure Sensor  
**EL-SSR-150**

Filter Housing  
Bracket Duplex  
**FT-FHB-10HD**

High Pressure Filter Housing (Lid & Bowl)  
**FT-FTH-10H**  
Filter Housing O-ring  
**SO-FHS-10**



1-Way Solenoid Valve 12V, 24V  
**PL-SLN-1/4O12SV, O24**

1/4" NPT X 5/8" Hose Barb El.  
**PL-HBE-1/4X5/8**

3/4" Nipple  
**PL-NP-3/4N**



Sea Strainer (Lid & Bowl & Screen)  
**FT-STN-5**

3/4" NPT X 5/8" Hose Barb  
**PL-HBS-3/4X5/8**

Sea Strainer Screen  
**FT-STN-5S**  
Sea Strainer O-ring  
**SO-STN-5SS**

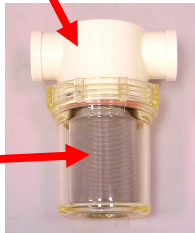

1/2" Nipple  
**PL-NP-1/2N**

1/2" X 1/4" Bushing Reducer  
**PL-BSH-1/2X1/4N**

1/2" NPT X 5/8  
Hose Barb  
**PL-HBS-1/2X5/8**

1/2" Female Tee  
**PL-TEE-1/2FN**

Pressure Gauge  
**PL-PSG-LP2.5**

Accumulator Tank  
**PL-ACC-TK**





## Parts I.D.

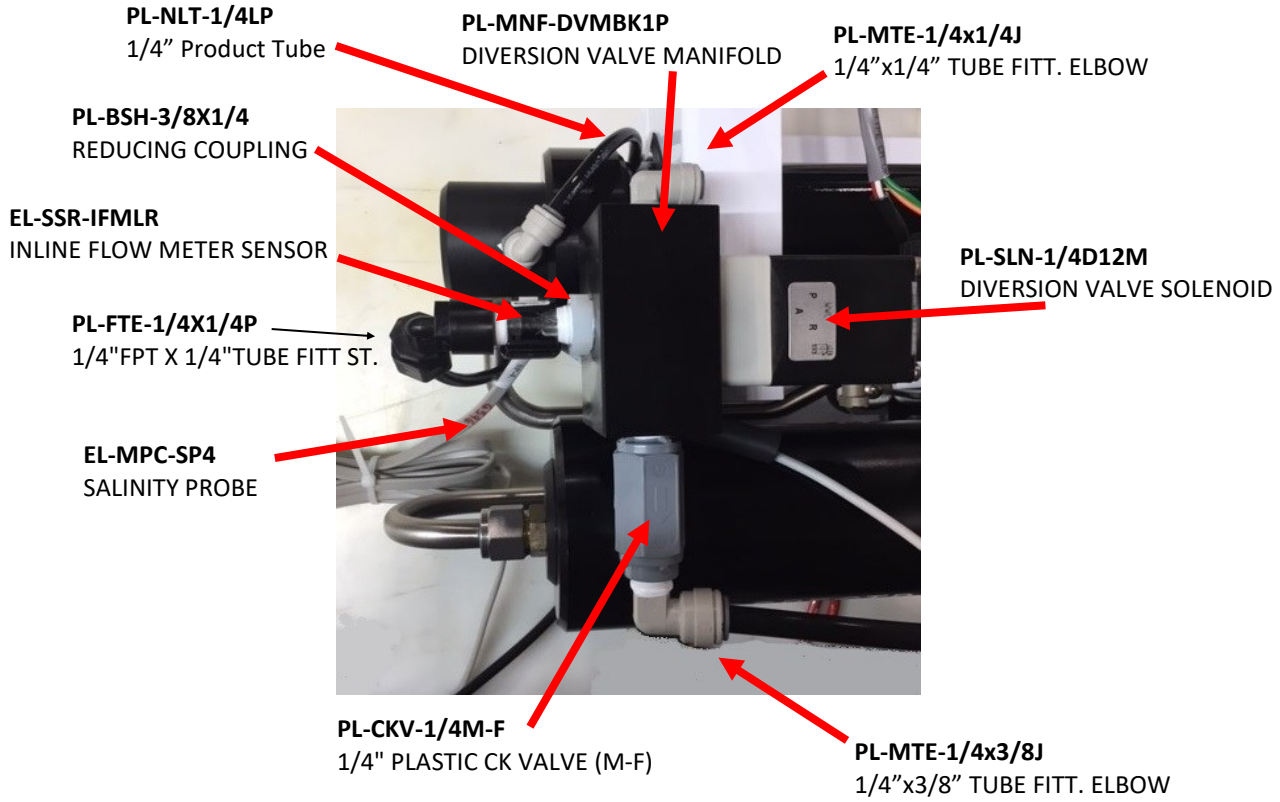



# Parts I.D.

Pump Head Assembly W/Press. Switch  
**PL-PMP-SFPH**

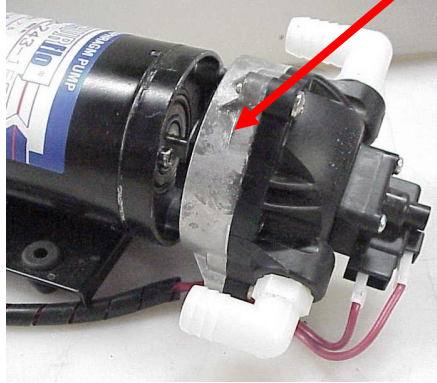

3/8" Low Pressure Tube  
**PL-NLT-3/8LP**

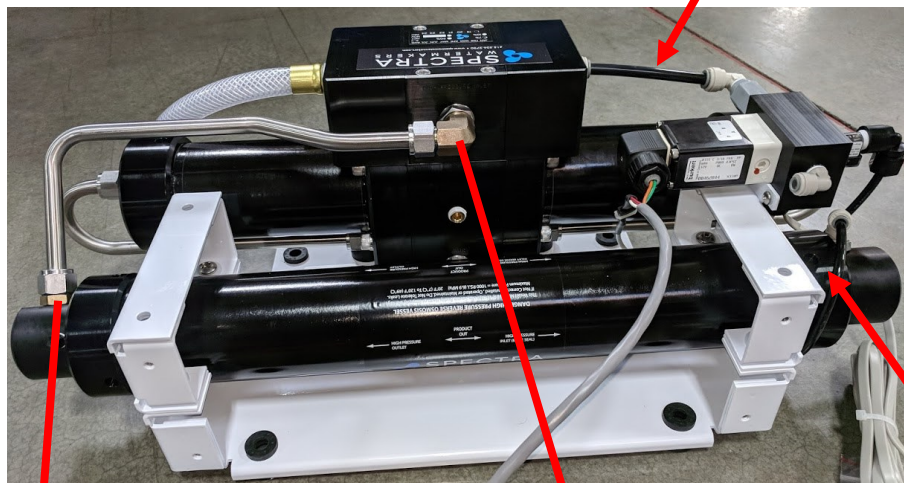

1/4" Product Tube  
**PL-NLT-1/4LP**

3/4"-16 Straight Thread  
O-RING  
**SO-FT-STF**

1/2" Stainless Ferrule  
**PL-HWR-1/2FR**

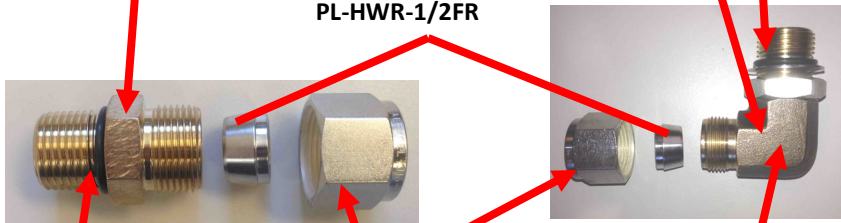

Connector O-RING  
**SO-HPP-CT**

Stainless Fitting Hex Nut  
**PL-HWR-1/2HN**

3/4"X 1/2" Tube Fitting  
Nickel-Bronze Elbow  
**PL-MTE-3/4S1/2B**

# Parts I.D.

3/4" NPT X 1/2" Hose Barb Elbow  
**PL-HBE-3/4X1/2**

1-Way Solenoid Valve 12V, 24V  
**PL-SLN-1/4O12, 024**

3/4" 3-Way Valve  
**PL-VLV-3W3/4**

Cooling Fan 12V, 24V  
**KIT-FK-12,24**

Feed Pump Heat Sink  
**EL-FP-FPHS**

Clear Filter Housing (Bowl & Cap)  
**FT-FTH-10L3PCS**  
 Clear Filter Housing O-ring  
**SO-FHS-3PCS10**



Ventura Feed Pump Bracket  
**FM-VT-ITM**

3/4" NPT X 5/8" Hose Barb  
**PL-HBS-3/4X5/8**

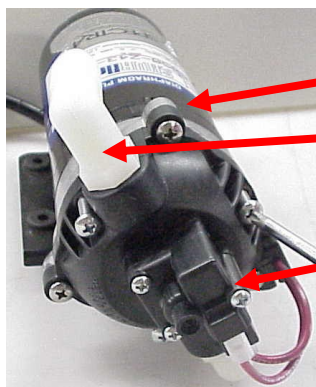

Feed Pump 12V, 24V  
**EL-FP-12V, 24V**

3/8" NPT X 5/8" Hose Barb El.  
**PL-HBE-3/8X5/8**

Feed Pump Pressure Switch  
**EL-FP-PS**

**EL-SWT-TSBHC**  
 TOGGLE SWITCH BOOT SEAL

**EL-TS-5000-CTRL**  
 KATADYN-5000  
 CONTROL BOARD

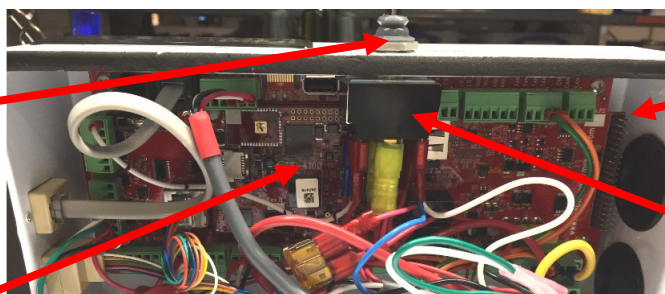

**FM-MPC-MPCB**  
 MPC BOX

**EL-SWT-TG-DPDT**  
 TOGGLE SWITCH  
 DP/DT

**EL-RL-40A12** 12V, 40A CUBE RELAY or  
**EL-RL-40A24** 24V, 40A CUBE RELAY  
 -Voltage specific, one per system, not shown

## Parts I.D.

### Remote Display



**KIT-SC-RMPNL**  
SPECTRA CONNECT REMOTE CTRL  
DISPLAY 4.3" (Comes with 100' of CAT-5 Cable)  
**KIT-SC-RMPNLD**  
(Remote Display ONLY)

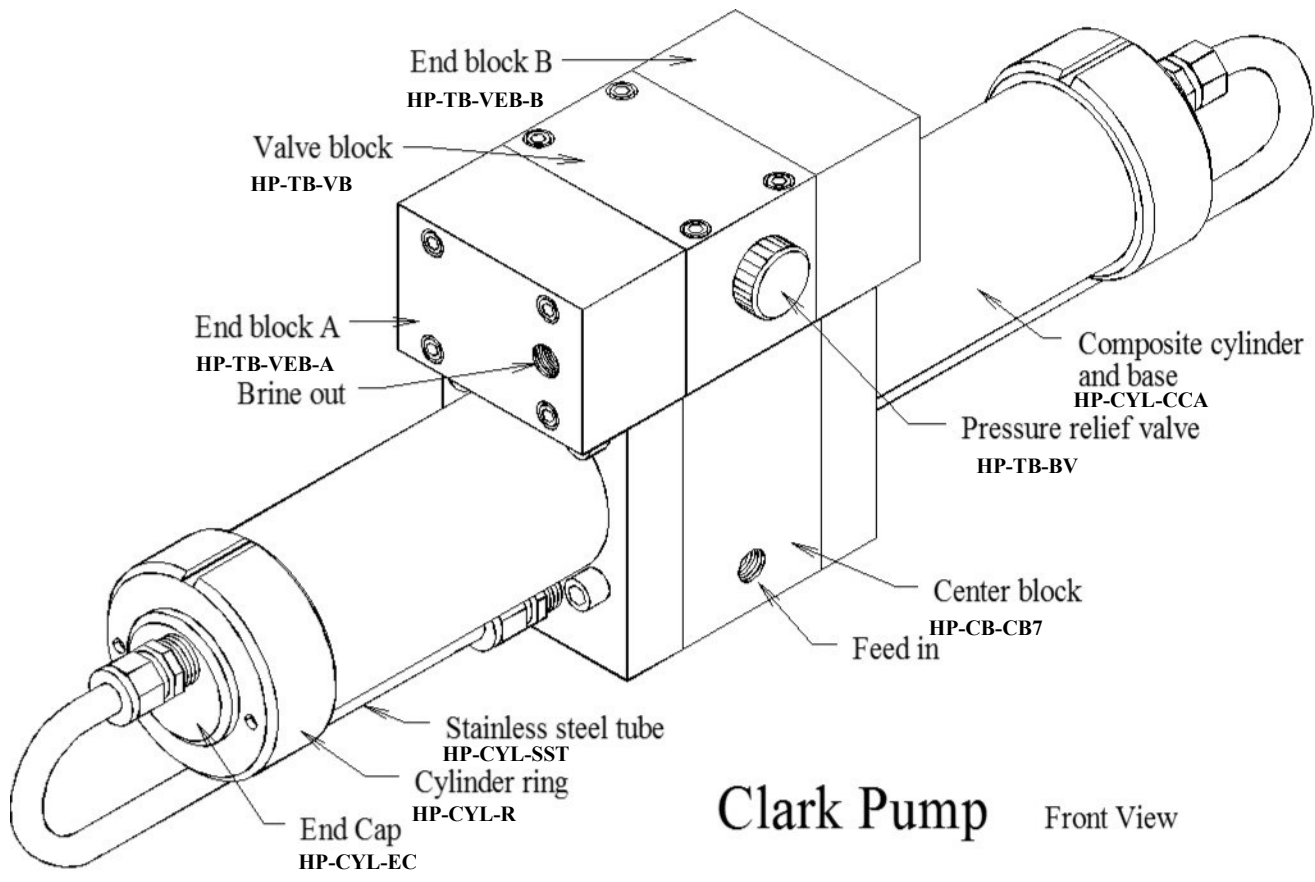

**Clark Pump** Front View

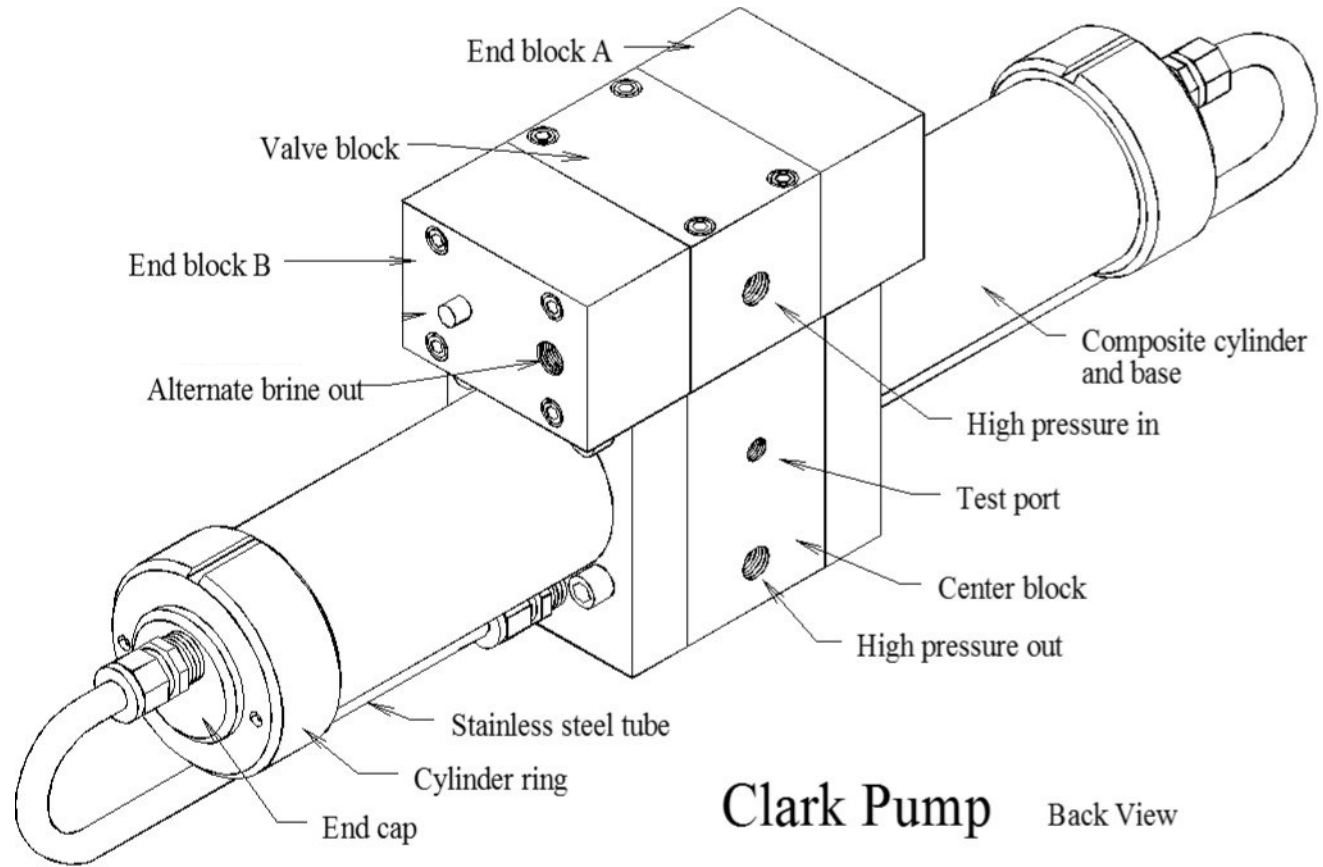

**Clark Pump** Back View

Spool Assembly  
Exploded View

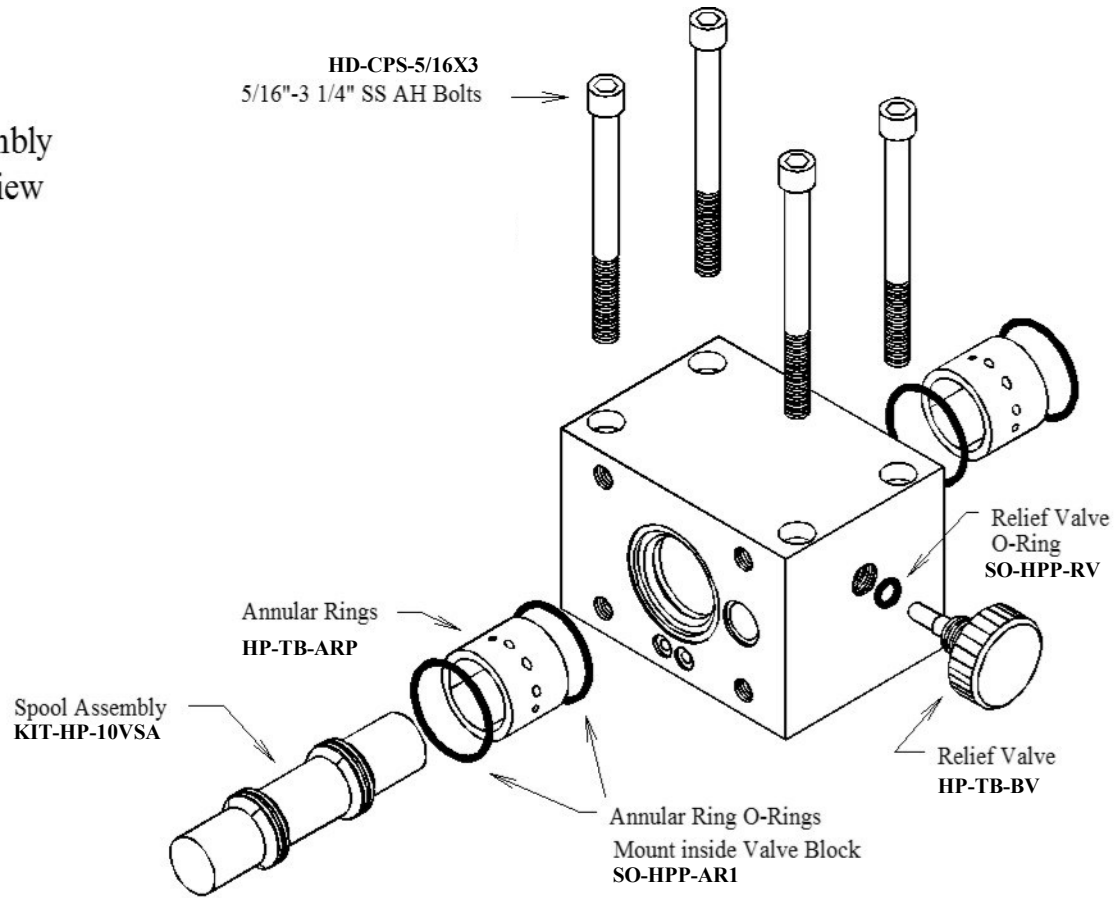

Valve Block

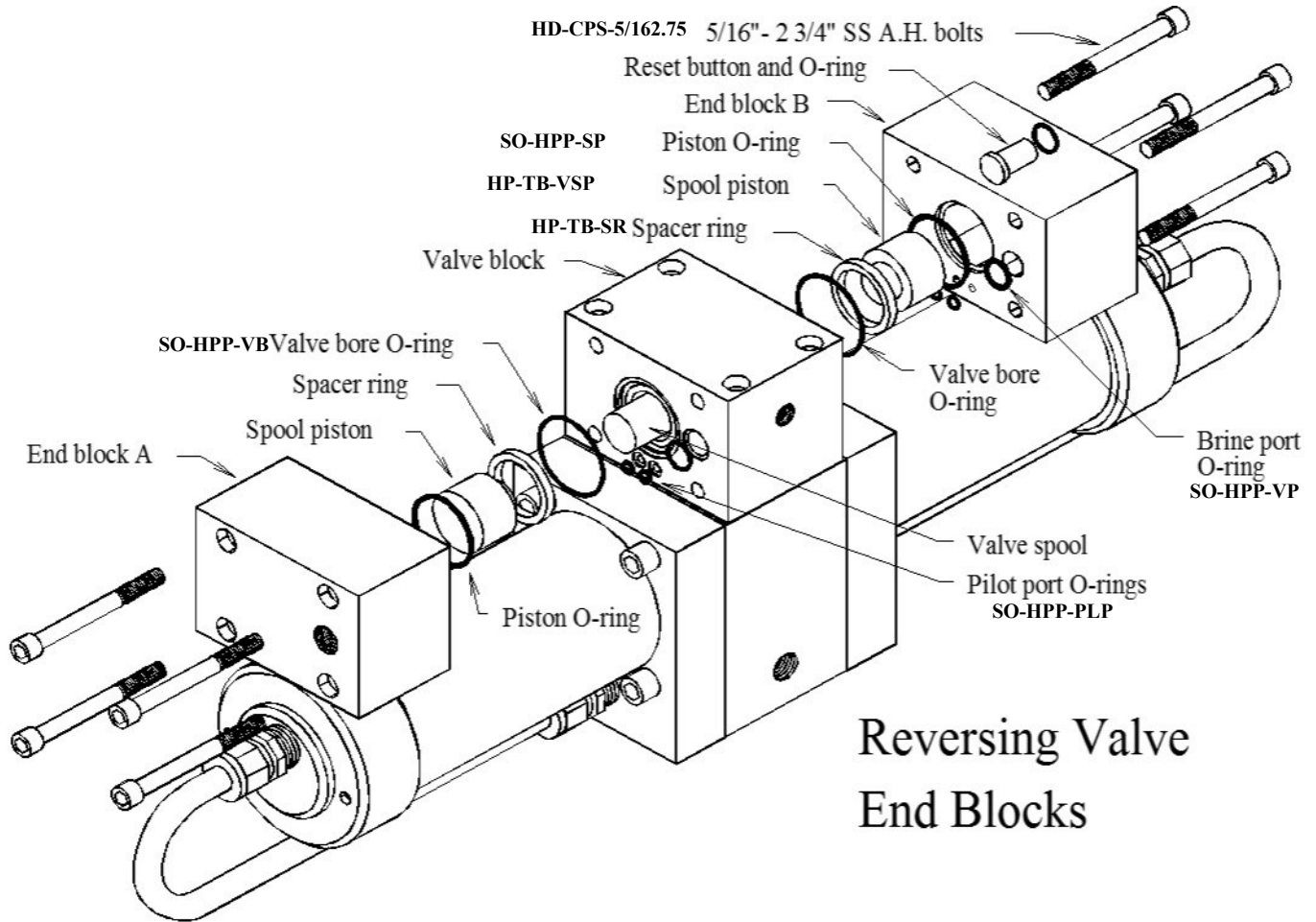

Reversing Valve  
End Blocks

# Parts

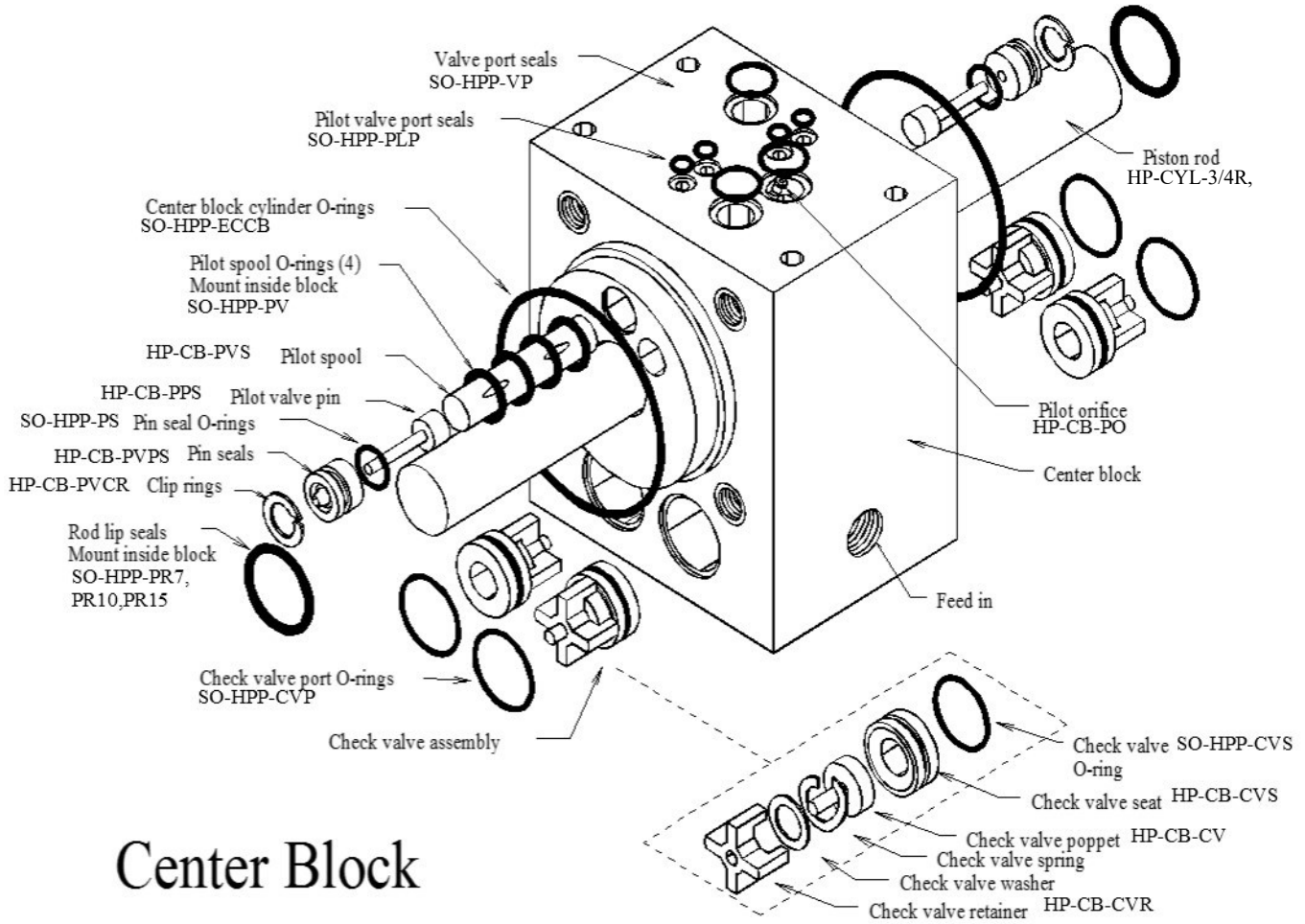

# Center Block

# Parts

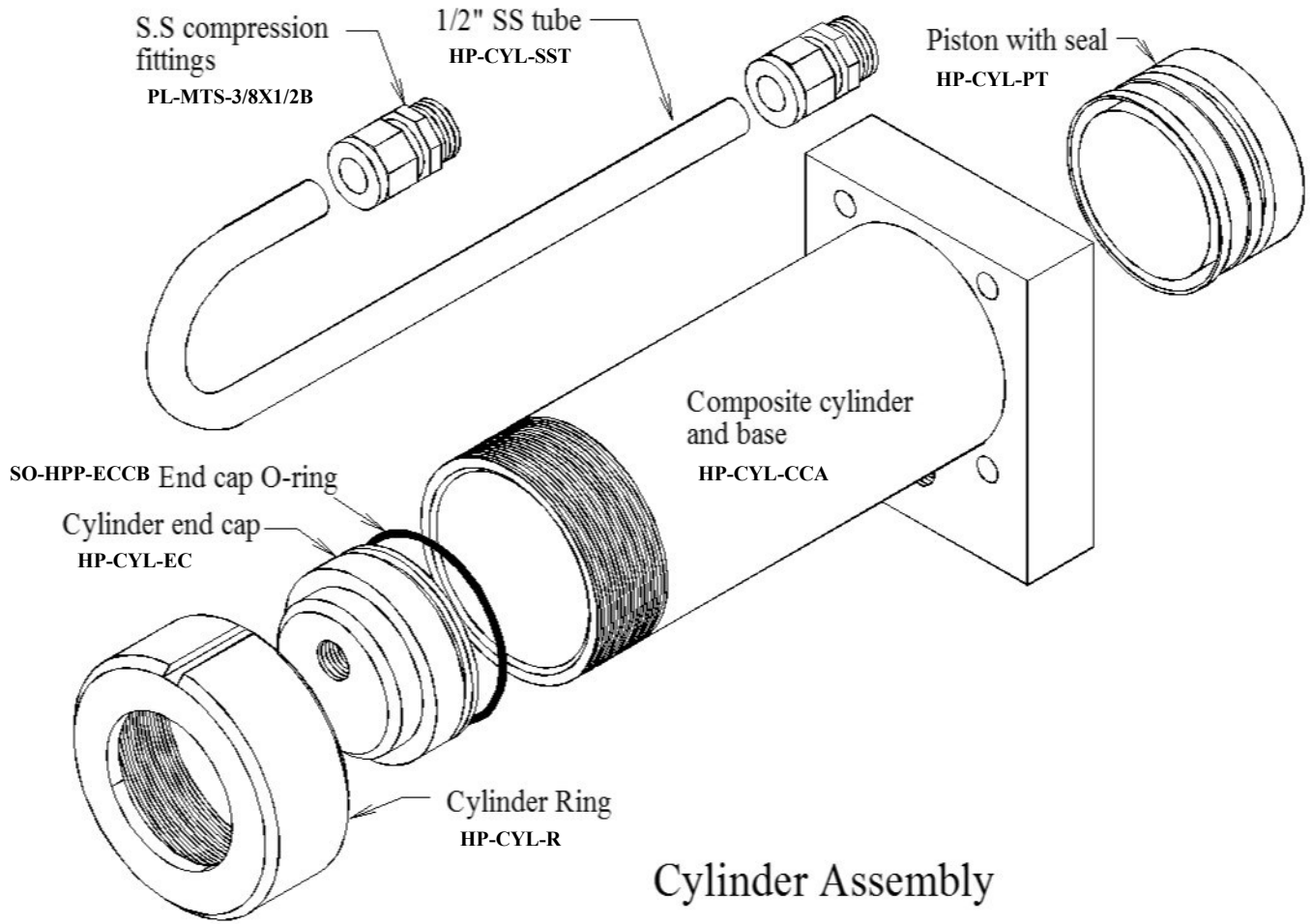





# Spectra Watermakers. Making fresh water worldwide.

Spectra Watermakers is a Katadyn Group Brand.

**KATADYN GROUP**  
SWITZERLAND

## SPECTRA WATERMAKERS

### SPECTRA WATERMAKERS LIMITED LIFETIME WARRANTY

THIS LIMITED WARRANTY APPLIES TO THE ORIGINAL OWNER OF THE WATERMAKER AND IS NOT TRANSFERRABLE

For warranty information regarding products sold within the European Union please contact [eu-  
rope@spectrawatermakers.com](mailto:eu-<br/>rope@spectrawatermakers.com).

This limited product warranty is provided by Katadyn Desalination LLC, a Business Unit of the Katadyn Group. (“Manufacturer” of “We” or “Our”) to the original, consumer owner of the product (“You” or “Your”) with which this limited product warranty is provided (the “Product.”)

The Manufacturer warrants to You that the product will be free from defects in material and workmanship under normal use and regular service and maintenance, subject to the exclusions described below, for a period of 1 year (the “Warranty Period”) after date of installation, or 15 months after the shipment date, whichever comes first. This warranty will be extended for an additional 12-month period when the product is installed and commissioned by a Katadyn Desalination Authorized Installer. A Spectra Watermakers Commissioning Report must also be returned and approved by the factory. The Spectra Clark Pump has a Limited Lifetime Warranty on Marine systems to the original consumer owner of the product, not inclusive of repair or replacement parts due to wear over time. If the Spectra Clark Pump is used in a Landbased application, the product warranty is provided for a period of 1 year (the “Warranty Period”) after date of purchase (if purchaser is installing system) or date of commissioning (if Spectra dealer is installing system).

You will be required to show written documentation supporting the date of purchase or date of commissioning. If you are unable to provide documentation supporting the date of purchase or commissioning, the warranty period shall be based on the product’s date code and will be determined by the Manufacturer’s sole and absolute discretion.

### WHAT IS COVERED

Katadyn Desalination LLC. warrants, for the period defined above, that the Product will be free from defects in materials and/or workmanship and will conform to Manufacturers published specifications if installed and maintained in accordance with the Manufacturers Instructions.

### WHAT IS NOT COVERED

The Warranty does not include service, repair, or replacement to correct damage caused by improper installation, maintenance, improper connection with water systems, external electrical fault, accident, alteration, misuse, abuse, neglect, negligence, (other than Manufacturer’s), acts of God, failure to install or maintain the product in accordance with the Manufacturers instructions.

### DAMAGED OR MISSING PRODUCT

You must examine the Product upon receipt and notify Katadyn Desalination LLC. if any item is damaged or missing within 30 days from the date of the delivery. Damage due to freight must be reported to Katadyn Desalination LLC. and to the freight carrier within 24 hours of delivery.

## SOLE WARRANTY

THE WARRANTIES SET FORTH IN THIS SECTION ARE THE SOLE AND EXCLUSIVE WARRANTIES GIVEN BY THE MANUFACTURER WITH RESPECT TO THE PRODUCTS AND ARE IN LIEU OF AND EXCLUDE ALL OTHER WARRANTIES, EXPRESS OR IMPLIED, ARISING BY OPERATION OF LAW OR OTHERWISE, INCLUDING WITHOUT LIMITATION, MERCHANTABILITY AND FITNESS FOR A PARTICULAR PURPOSE WHETHER OR NOT THE PURPOSE OR USE HAS BEEN DISCLOSED TO MANUFACTURER IN SPECIFICATIONS, DRAWINGS OR OTHERWISE, AND WHETHER OR NOT MANUFACTURER'S PRODUCTS ARE SPECIFICALLY DESIGNED AND/OR MANUFACTURED BY MANUFACTURER FOR YOUR USE OR PURPOSE.

## WHAT WE WILL DO TO CORRECT PROBLEMS

If You return the defective product during the warranty period and in accordance with the instructions contained herein, shipping prepaid, the Manufacturer shall, at its option and as Your exclusive remedy, repair, correct or replace the product at no charge if the product is found by the Manufacturer to be a valid warranty claim, in Manufacturer's sole discretion. Replacement product may be refurbished and/or different models but will be functionally equivalent to the product or hardware being replaced. Product repaired or replaced during the warranty period shall be covered by the foregoing warranty for the remainder of the original warranty period or ninety (90) days from the date of shipment or purchase, whichever is longer. Contact your Dealer or the Manufacturer's Customer Service at 415-526-2780 to obtain a returns materials authorization (RMA #).

## HOW TO MAKE A WARRANTY CLAIM

If You discover any warranty related issues after 30 days, or You have questions concerning Your product or how to determine when service is needed, please contact your local dealer or contact the Manufacturer's Technical Support at 415-526-2780 or email the Manufacturer at [techsupport@spectrawatermakers.com](mailto:techsupport@spectrawatermakers.com). The following information must be provided as part of Your warranty claim: your name, address, phone number, Your products' model number, Your product's 4-digit serial number, and if necessary, upon request, written confirmation of the date shown on Your purchase receipt and the purchase price paid for the product. All products being returned to the Manufacturer must have a return material authorization (RMA) number to be processed. Any item returned to the Manufacturer without an RMA number will not be accepted by the Manufacturer. Contact your Dealer or Customer Service to obtain an RMA number. Once we have received Your returned product, we will determine, in our sole and absolute discretion, whether Your claim is covered by, or excluded from, this limited warranty. Repairs or modifications made to the product by other than the Manufacturer will nullify this limited warranty. Coverage under this limited warranty is conditioned at all times upon the original purchaser's compliance with these required notification and repair procedures.

LIMITATION OF LIABILITY TO THE FULLEST EXTENT PERMITTED BY LAW, IN NO EVENT, SHALL MANUFACTURER OR ITS AUTHORIZED SERVICE REPRESENTATIVES BE LIABLE FOR ANY INCIDENTAL, SPECIAL, INDIRECT, OR CONSEQUENTIAL DAMAGES, INCLUDING ANY ECONOMIC LOSS, WHETHER RESULTING FROM NONPERFORMANCE, USE, MISUSE OR INABILITY TO USE THE PRODUCT OR THE MANUFACTURER'S OR ITS AUTHORIZED SERVICE REPRESENTATIVE'S NEGLIGENCE. THE MANUFACTURER SHALL NOT BE LIABLE FOR DAMAGES CAUSED BY DELAY IN PERFORMANCE AND, IN NO EVENT, REGARDLESS OF THE FORM OF THE CLAIM OR CAUSE OF ACTION (WHETHER BASED IN CONTRACT, INFRINGEMENT, NEGLIGENCE, STRICT LIABILITY, OTHER TORT OR OTHERWISE), SHALL MANUFACTURER'S LIABILITY TO YOU EXCEED THE PRICE PAID BY THE ORIGINAL OWNER FOR THE MANUFACTURER'S PRODUCT.

The term "consequential" damages shall include, but not be limited to, loss of anticipated profits, business interruption, loss of use or revenue, the cost of capital or loss or damage to property or equipment. Some states do not allow the exclusion or limitation of incidental or consequential damages, so the above limitation may not apply to you. This limited warranty gives you specific legal rights, and you may also have may other rights which vary from State to State.

## Spectra Product Registration Form

**Any commissioning/install report (and additional 12 month warranty) may be rejected at the sole discretion of Spectra Watermakers if the system is not installed correctly.**

**Registration (To be completed by owner)**

**System Details:**

Model \_\_\_\_\_ Date of install: \_\_\_\_\_  
 4-digit S/N \_\_\_\_\_ Clark Pump S/N: \_\_\_\_\_ Voltage \_\_\_\_\_  
 Dealer/distributor: \_\_\_\_\_ Boat Location: \_\_\_\_\_ max speed: \_\_\_\_\_

Boat model or type (i.e. Leopard 44, Beneteau 55' powerboat, catamaran, powercat, 42' sailboat...)

What type of boating will you be doing and what will the watermaker primarily be used for:

**Original Owner Details:**

Name: \_\_\_\_\_ Phone Number: \_\_\_\_\_  
 Email Address: \_\_\_\_\_  
 Address (Optional): \_\_\_\_\_  
 \_\_\_\_\_  
 \_\_\_\_\_

**Submission for Approval:**

Please submit this document along with the Installation and Commissioning Reports to Spectra Watermakers for approval. Submissions can be **submitted online**, scanned and emailed, or mailed directly to the factory. Spectra Watermakers Technical Support will email the original owner and the authorized distributor with the status of submission.

Web-Based Format (Preferred option):

[spectrawarranty.formstack.com/forms/product\\_registration](http://spectrawarranty.formstack.com/forms/product_registration)  
[spectrawarranty.formstack.com/forms/spectra\\_install\\_commissioning\\_report](http://spectrawarranty.formstack.com/forms/spectra_install_commissioning_report)

Email: [TechSupport@SpectraWatermakers.com](mailto:TechSupport@SpectraWatermakers.com)

Phone: +1(415) 526-2780

Address: Katadyn Desalination  
 Technical Department  
 2220 S. McDowell Blvd Ext  
 Petaluma, CA 94954  
 USA

**Please keep a copy of these reports for your records.**



--- CUT HERE ---

## Spectra Watermakers Installation Report

(To be completed by authorized installer)

The following checklist is designed to confirm that the watermaker installation meets Spectra standards. Fill out the checklist as completely as possible. Check any boxes that apply and note any concerns. Please document any discrepancies or concerns with photos.

### INLET

- Inlet Seacock is below waterline
- Inlet Seacock is dedicated
- Inlet Seacock is shared
- Inlet Thru-Hull forward facing scoop
- Has strainer
- Has diving snorkel
- Sea chest
- Other

Thru Hull Size: \_\_\_\_\_ IN/CM

Approximate location on vessel and notes: \_\_\_\_\_

### FEED PUMP MODULE

- Feed pump module is mounted upright
- Clearance for filter cartridge changes
- Intake hoses are free of kinks
- Pressurized domestic water is connected to carbon filter

Distance from waterline: \_\_\_\_\_ FT/M above"/below" the waterline

### HIGH PRESSURE MODULE and BRINE DISCHARGE

- Pressure relief valve is accessible
- Brine discharge has no obstructions and vents to atmosphere

Notes: \_\_\_\_\_

### PRODUCT WATER TUBING

- Product water flows into top of freshwater tank
- Freshwater tank is vented

### INSTALLATION SIGN OFF

Technician's Name: \_\_\_\_\_ Date: \_\_\_\_\_

Technician's Signature: \_\_\_\_\_

Distributor/Dealer \_\_\_\_\_





--- CUT HERE ---

Spectra Watermakers Commissioning Report – Page 1
(To be completed by authorized installer)

The following checklist is designed to confirm that the watermaker installation meets Spectra standards and that the system is performing at specification.

Fill out the below checks as completely as possible. Check any boxes that apply and note any concerns.

PURGE

- Storage Chemicals have been purged with PRV open

Length of purge: \_\_\_\_\_ Minutes

- Diversion Valve is up, in reject position
Filter condition has been calibrated
"Run Manual" switch engages full speed
"Service" switch engages flush speed

RUN HIGH MODE CHECKS

Product Flow: \_\_\_\_\_ GPH/LPH

Confirmed Product Flow Rate \_\_\_\_\_ GPH/LPH

- Technician Flow meter. Brand \_\_\_\_\_
Hand Measurement \_\_\_\_\_ Gal/Liters in \_\_\_\_\_ SEC/MIN

Product Quality: \_\_\_\_\_ PPM

- Confirmed product quality with handheld TDS meter

Feed Pressure: \_\_\_\_\_ PSI/BAR

Boost Pressure (with clean prefilters): \_\_\_\_\_ PSI/BAR

Brine Flow Rate: \_\_\_\_\_ GPM/LPM

Measurement taken with:

- Technician Flow meter. Brand \_\_\_\_\_
Hand Measurement: \_\_\_\_\_ Gal/Liters in \_\_\_\_\_ SEC/MIN
Boost Pump runs
Output and motor speed decrease when low mode is engaged

Notes: \_\_\_\_\_

FRESHWATER FLUSH

- Freshwater Flush solenoid valve opens
Feed Pump is not cavitating when system flushes with seacock closed

Ship's pressurized freshwater pump flow & pressure rating \_\_\_\_\_ GPM/LPM \_\_\_\_\_ PSI/BAR

When seacock is open, what is the ppm of brine discharge at the end of the flush \_\_\_\_\_

Flush duration is \_\_\_\_\_ Minutes

- Needed to change flush time
Needed to change speed of feed pump during flush

Notes: \_\_\_\_\_

\*If the system does not have a dedicated forward-facing scoop type thru-hull or will be on a vessel that moves faster than 15 knots the system needs to complete the following sea trial checks. Spectra Watermakers reserves the right to require a sea trial from any customer before approving a commissioning report.

SEA TRIAL

- Watermaker will flush while underway
Watermaker will start while underway

While the vessel is underway moving \_\_\_\_\_ KNOTS/MPH/KPH the watermaker is producing \_\_\_\_\_ GPH/LPH at \_\_\_\_\_ PPM

# Spectra Watermakers Commissioning Report – Page 2

## OWNER EDUCATION

Owner has been trained on the following:

Know locations of

- Seacock/Thru-hull
- Sea strainer
- Feed Pump Module
- Prefilter Module
- Freshwater Flush Module
- High Pressure Module
- Control Box and RUN MANUAL toggle switch
- Clark Pump Pressure Relief valve
- Product water inlet to Freshwater Tank
- Brine Discharge location
- Service hoses and storage chemicals
- User Manual

- How to power the watermaker off and on at the main breaker.
- How to run the watermaker.
- How to freshwater flush and the importance of freshwater flushing.
- Knows when the ships domestic freshwater pump is on.
- Knows which prefilter cartridges to use and how to change them.
- Knows how to service the sea strainer module.
- Knows where the carbon block filter is and is familiar with (6 months) service frequency.
- Knows how to run the system via "RUN MANUAL." Including knowing how to bypass the diversion valve and sample the product water before it enters the tank.
- Understands the risks of running the system in run manual.
- Have visually seen the overboard brine discharge (Should know when the system is pumping water).
- Know where freshwater enters the tank, would be able to manually sample/taste water if necessary.
- Understand when the Clark Pump is under pressure and cycling.
- Have seen how the service hoses and bucket are used to circulate seawater or freshwater through the system.
- Have heard the difference speeds of the vane pump (the difference between Run Hi and Service speed.)

Notes: \_\_\_\_\_

\_\_\_\_\_

\_\_\_\_\_

\_\_\_\_\_

\_\_\_\_\_

\_\_\_\_\_

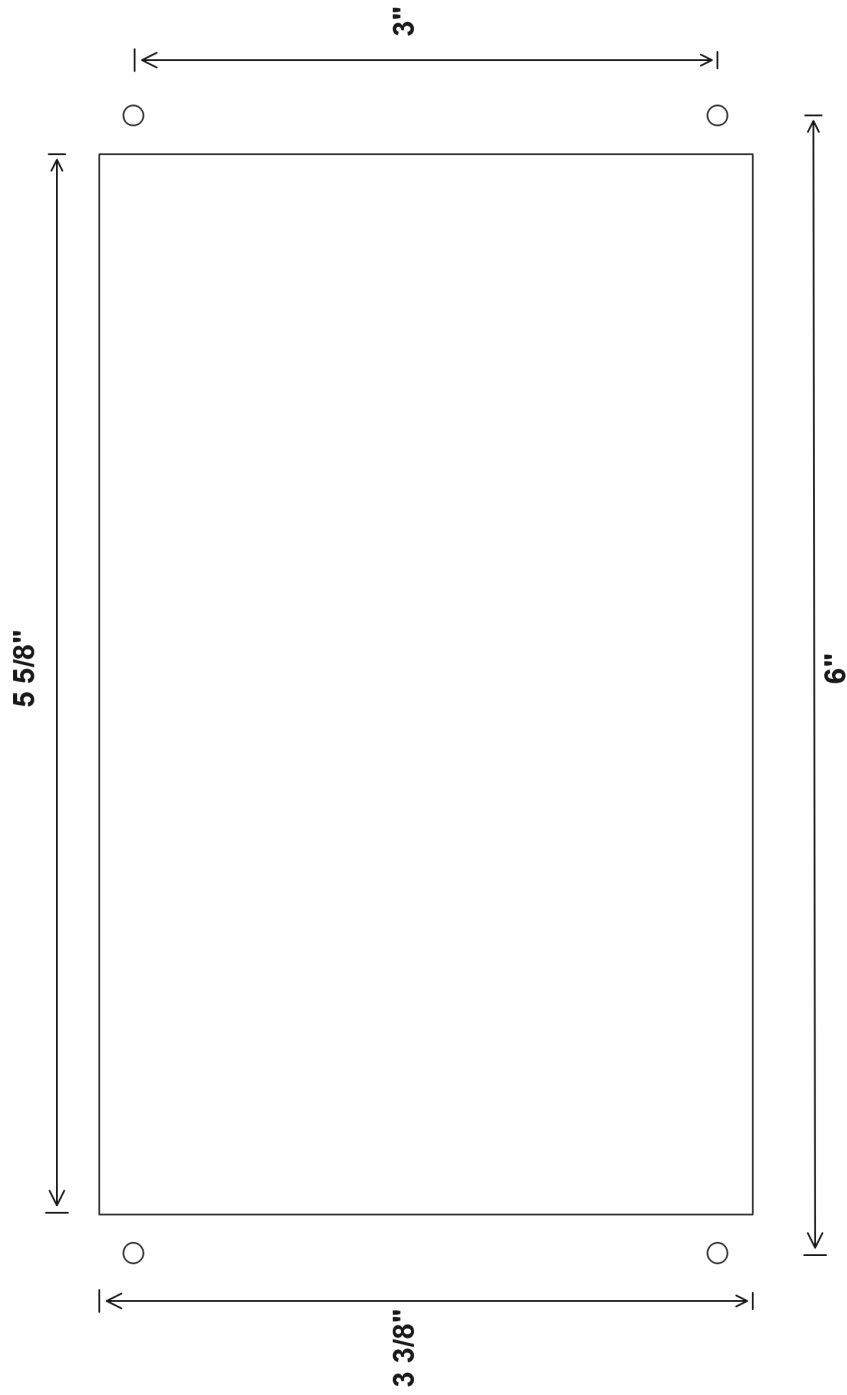

**Spectra Connect Display Cutout**  
**Note:** Use this template to create a cutout to mount your Spectra Connect Remote Touchscreen Display in the desired location on your vessel.