



EK-4



EK-24

# ELECTRO-KATADYN INSTRUCTION MANUAL

## 1 Table of Contents

---

1	Table of Contents .....	1
2	Silver Ionization: What are the benefits? .....	3
3	Effect of Silver Ions on Bacteria Cells .....	4
4	General Safety Instructions .....	5
5	Quick Reference Control Cabinet .....	6
6	Quick Reference Layout of the EK-4 activator .....	7
7	Quick Reference Layout of the EK-24 activator .....	8
8	Technical data .....	9
8.1	Operating data .....	9
8.2	Environmental data .....	10
9	General details .....	11
10	Operating Panel .....	12
10.1	Start Screen .....	12
10.2	Overview Screen .....	13
10.3	Setting Screen .....	14
10.4	Alarm Screen .....	16
10.5	Alarm History and Trend Screen .....	17
11	Commissioning of the Electro-Katadyn System EK-4 / EK-24 .....	18
11.1	Basic components: .....	18
11.2	Environmental conditions .....	18
11.3	Short installing guide of the EK System .....	18
11.4	Mount the anodes to the activator EK-X/24 .....	19
11.5	Insert the anode into the EK-4 activator .....	20
11.6	Water inlet and outlet / drainage .....	21
11.7	Starting the Water Flow .....	22
11.8	Electrical connection .....	23
11.9	Starting the Electrical Control System .....	23
11.10	Current/Dosage adjusting of the EK .....	23
11.11	Local Setpoint .....	24
11.11.1	Remote Setpoint .....	24
11.11.2	Dosage control .....	24
11.12	Start/Stop silver ion (Ag+) production .....	25
11.12.1	Start/Stop Local .....	25
11.12.2	Start/Stop Remote .....	25
12	Installation options of EK systems .....	26
12.1	Sample System Layout <i>bypass</i> .....	26
12.2	Sample System Layout <i>marine</i> .....	26

12.3	Sample System Layout without bypass using direct flow <i>marine</i> .....	26
12.4	Sample P&I Layout <i>bypass</i> with automatic valves and flow measurement .....	27
13	The conductivity of the water .....	28
14	Monitoring and Maintenance .....	29
14.1	Basic Maintenance .....	29
14.2	Checking the Effect .....	29
14.3	Cleaning the Electrode System .....	29
15	Troubleshooting .....	31
15.1	Flow Low .....	31
15.2	Voltage High .....	31
15.3	Voltage Low .....	31
15.4	Temperature High .....	31
15.5	Overvoltage .....	31
15.6	Short Circuit .....	32
15.7	Communication Error .....	32
16	Packaging and Transport .....	33
17	Appendix .....	34
17.1	Spare Parts for Electro Katadyn EK-4 .....	34
17.2	Spare Parts for Electro Katadyn EK 2-6/24 .....	34
17.3	Dimensions EK 4 .....	35
17.4	Dimensions EK 24 .....	36
17.5	Electrical connection .....	37
17.6	Electrical connection Activator Anode/Cathode .....	39
17.6.1	EK-4 .....	39
17.6.2	EK-24 .....	40
18	CE declaration of conformity .....	41

## 2 Silver Ionization: What are the benefits?

---

Silver has been used for centuries as a way to prevent or reduce bacterial growth. In ancient times cultures discovered that water stored in silver pots had a longer useable life than other types of pots. Today silver is used in a variety of bacteria-reducing & preservation applications from clothing to water purification.

The Electro Katadyn (EK) system uses electrical modulation of the catalytic process to introduce silver ions into water flowing through the system. Based on Faraday's law and system design, as parts per million amount of silver ions are introduced into the water. At various concentrations, this ion-enriched water preserves drinking water, is used for rinse and disinfection of food equipment, or in hot water systems to prevent Legionella growth.

Silver ionization offers additional benefits in simplicity, maintenance and eco-friendly processes.

Compared to liquid or gas chemical treatment, ionization offers a much simpler process. Depending on the application and volume required, the EK system can be piped into a bypass or direct line to deliver the ions. It does not require separate chemical pumping, dose control and contact tanks to ensure safety. The Electro-Katadyn system use of Silver anodes means operators aren't constantly adding new chemical mixtures to the process and reduces the chances of under- or overdosing the water in normal operation. This reduces the complexity and logistics required to support the chemicals as well as any additional safety protocol equipment.

The Katadyn EK silver ionization system is easy to maintain. Anode changes are simple mechanical replacements requiring no electrical or special materials handling by site operators.

Katadyn anodes are a fraction of the volume of liquid or gas containers used by other treatment methods. The small size of the anodes reduces the freight costs and carbon footprint, handling and packaging required for operating the system. The overall system has a much smaller footprint also reducing the associated capital costs for space for the client.

The EK 24 systems offer users two types of solutions:

Normal water treatment (conductivity > 100  $\mu$ Siemens) for preservation, legionella or cleaning applications are covered by the standard EK x-24 units.

Customers with low conductivity water (conductivity 10 to 100  $\mu$ Siemens), typically marine or Food and Beverage production, can benefit from the EK x-24 LC units.

### 3 Effect of Silver Ions on Bacteria Cells

The bactericidal action of silver ( $Ag^+$ ) is known as the “Katadyn” effect, a fusion of “catalytic” (i.e. and “oligodynamic.” It means the destruction of micro-organisms by catalysis, using very small amounts of dissolved silver (oligos = small; dynamis = force).

A typical bacteria cell has the following key components:

- **Cell wall & membrane:**  
Provides protection and controls the movement of substances into and out of the cell

- **Chromosomes:**  
Contain DNA used in reproduction

- **Cytoplasm:**  
Contains water, proteins and

enzymes

that help in cellular growth metabolism

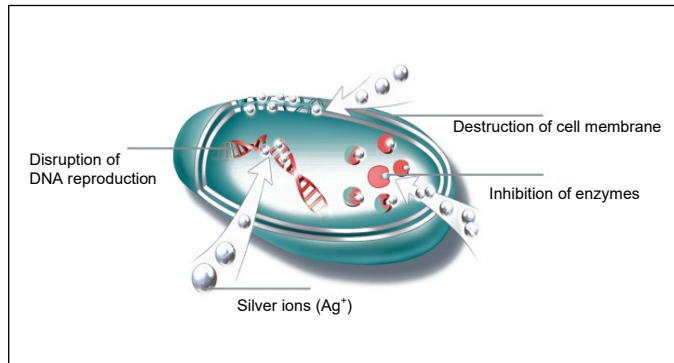

Silver ions ( $Ag^+$ ) have a high affinity towards sulphur as well as phosphorous and easily get attached to thiol (-SH) groups, which are sulphur containing organic compounds found in proteins and enzymes.

The positively charged silver ions ( $AG^+$ ) affect the bacteria cells in the following ways:





- a. Bonding to thiol groups in the protein of the membrane wall, causing pores in the membrane walls that allow more silver ions in
- b. Bonding to thiol groups in the cytoplasm proteins and enzymes, thus inhibiting them from supporting the cells basic support and growth functions
- c. Disrupting the hydrogen bonding within DNA strands and denaturing the DNA

A description of influences of silver in drinking water can be found in the following publications “Guidelines for drinking-water quality, 2nd. Ed. Vol. 2 *Health criteria and other supporting information*” published by WHO (Geneva, 1996).

#### 4 General Safety Instructions

### IMPORTANT

Please read the instruction manual before carrying out any work for the installation, operation and maintenance of the EK system.

	<p><b>ATTENTION!</b></p> <p>Indicates a potentially dangerous situation. Failure to observe this notice may cause slight or severe personal injury and property damage.</p>
	<p><b>ELECTRIC SHOCK!</b></p> <p>Warning of dangerous electrical voltage. Failure to observe this notice may result in serious injury or death.</p>
	<p>Before working with the EK system, it is imperative that the instruction manual be read and understood. Installation, commissioning, operation and maintenance of the EK system may be carried out only by authorized personnel.</p>
	<p>When working with an EK system, it is highly recommended that cut resistant gloves be worn.</p>
	<p>The disposal of scrap electronic and electrical goods, including silver anodes, as household waste is not permitted. Please dispose of this scrap material as per local regulations and with properly accredited waste management companies.</p>
	<p>Before working on the control cabinet or activator, be certain to pull out the power plug and wait at least 5 minutes until all components have discharged.</p>
	<p><b>NOTE</b></p> <p>Useful application notes for the operator and service personal</p>

**5 Quick Reference Control Cabinet**

---



1. Control panel (touch screen)
2. Mains connection with fuse
3. Mains Switch
4. Cable ingress

**6 Quick Reference Layout of the EK-4 activator**

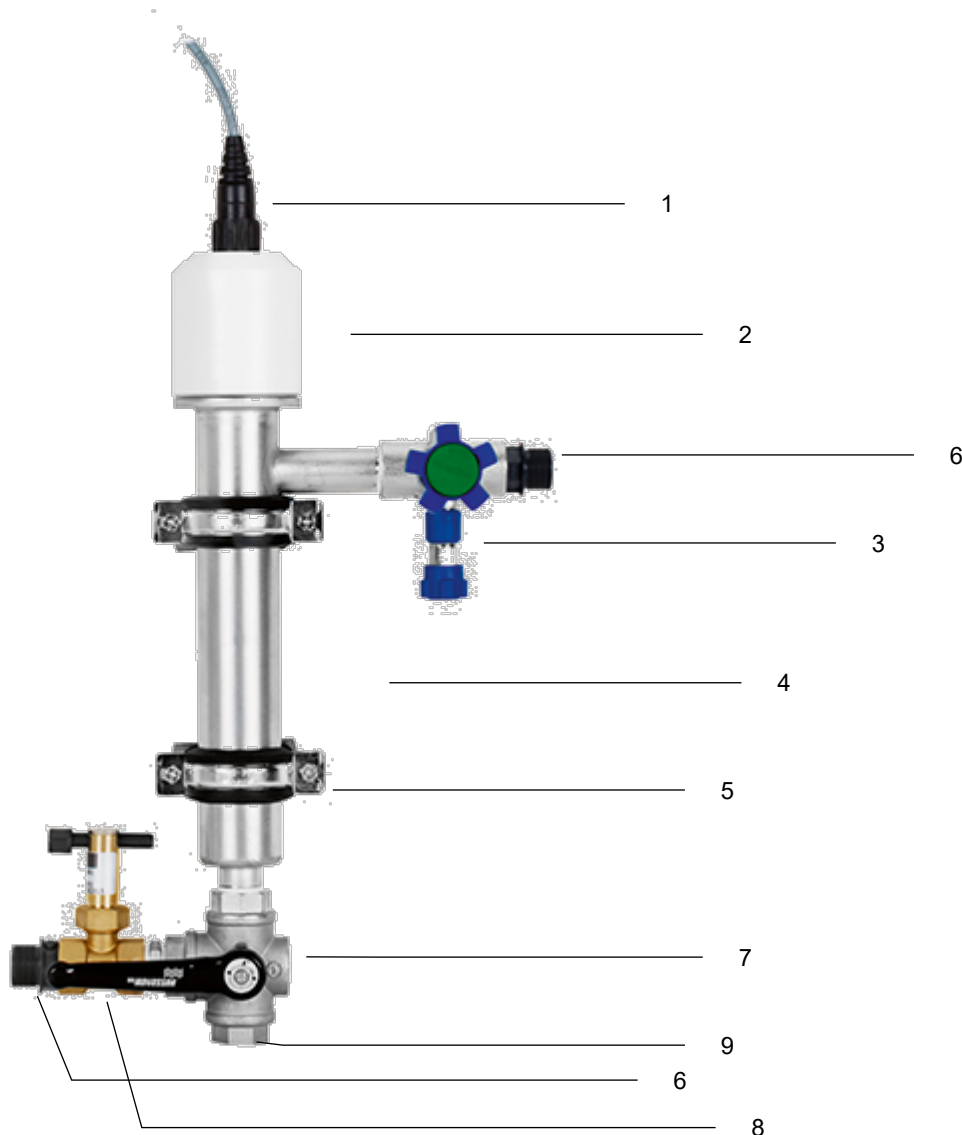

1. **Low power cable for electrolysis** (connected to control box)
2. **Protection cap**
3. **Water outlet needle valve G3/4" with probe valve**
4. **Activator body** (acts as cathode)
5. **Mounting clamps** (must be electrical isolated)
6. **Plastic isolation adapter G3/4"** (Important to isolate the activator)
7. **Water inlet ball valve G3/4"**
8. **Flow Switch G3/4"** (monitoring of water flow)
9. **Drain port G3/4**



## 7 Quick Reference Layout of the EK-24 activator

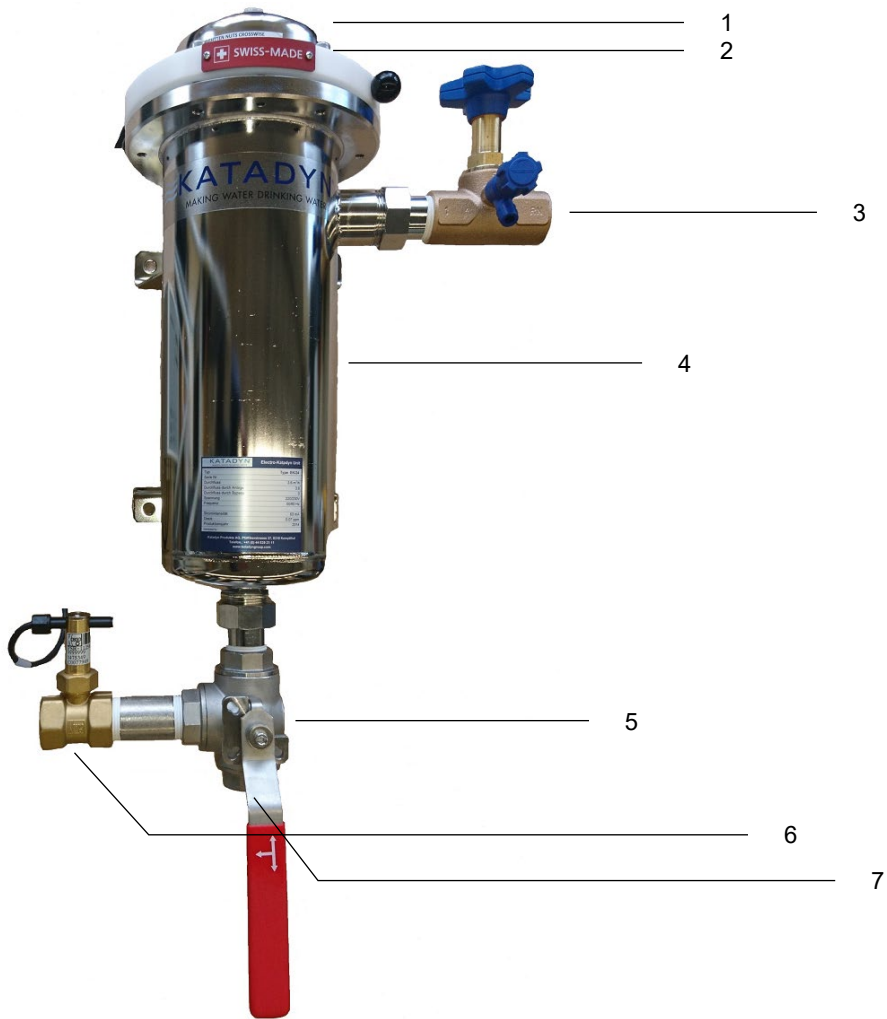

1. Low power cable for the electrolysis (screwed connection below metal cap)
2. Header with anodes and cathode system
3. Water outlet needle valve G1" with probe valve
4. Activator body
5. Water inlet ball valve G1"
6. Flow Switch G1"
7. Drain port G1"

## 8 Technical data

### 8.1 Operating data

Electro Katadyn					
Type of device	EK-4	EK 2-24	EK 3-24	EK 4-24	EK 6-24
Application					
Drinking water 0.02ppm	20m <sup>3</sup> /h	40 m <sup>3</sup> /h	60 m <sup>3</sup> /h	80 m <sup>3</sup> /h	120 m <sup>3</sup> /h
Cleaning Rinse water 0.5ppm	0.8 m <sup>3</sup> /h	1.6 m <sup>3</sup> /h	2.4 m <sup>3</sup> /h	3.2 m <sup>3</sup> /h	4.8 m <sup>3</sup> /h
Disinfected Cleaning water 1.0ppm	0.4 m <sup>3</sup> /h	0.8 m <sup>3</sup> /h	1.2 m <sup>3</sup> /h	1.6 m <sup>3</sup> /h	2.4 m <sup>3</sup> /h
Lifetime of the anode (est.)	20'000 m <sup>3</sup> (at 0.01 ppm Ag) 10'000 m <sup>3</sup> (at 0.02 ppm Ag)				
Conductivity drinking water	100 to 500 µS/cm				
Conductivity low	3 to 99 µS/cm				
Chloride (Cl)	Max. 25 ppm				
Organics (KMnO <sub>4</sub> )	Max. 10 ppm				
Activator housing					
No. of anodes of Type E1	1	2	3	4	6
Material of the body	1.4301 / 316S				
Nominal pressure (bar)	6 / PN6				
Weight (without water) kg	5.8	15.8	16.2	16.6	17.3
Dimensions					
Height mm	500	605			
Diameter mm	64	140			
Connections (inlet / outlet)	G 3/4"	G 1"			
Mounting position	Vertical				
Control Cabinet					
Dimensions mm (w x h x d)	300 x 400 x 155				
Weight kg	9.8				
Electrical supply	230/120V 50/60Hz				
Nominal power	40W				
Protection class	IP64				
Remote Interface (see attachment 17.5)					
6 Remote relay output: 4 Remote Input : 2 Analog Input:	Potential free relay contacts (max.240VAC/2A/24VDC) Contact closed 24VDC from cabinet 0-10VDC				

## 8.2 Environmental data

Electro Katadyn					
Type of device	EK-4	EK 2-24	EK 3-24	EK 4-24	EK 6-24
Environment					
Ambient operating temperature	5 to 40°C				
Ambient operating humidity	10 - 85% non-condensing				
Storage and transportation temperature	-25 to 55°C				
Max. altitude	3000 m above sea level				
Aggressive environment	to be avoided				
Shock and vibration	low vibration environment				

## 9 General details

---

### Maintenance manual

	<p><b>NOTE</b></p> <p>The system must be installed, operated and maintained in accordance with this instruction manual. In our experience, the information and instructions contained in the manual will guarantee maximum operational safety for the system. The instruction manual is to be retained for future reference.</p>
---	--

### Warranty claims

All rights to claim for damage under warranty will be invalidated:

- if safety, operating, maintenance and repair instructions are not observed,
- if any work on the system is carried out improperly, and unsuitable equipment is used,
- if the EK system, or individual components thereof, are used for purposes which do not comply with the specification and application
- if unauthorized changes are made to the EK system,
- if original Katadyn replacement parts are not used,
- if work is carried out, particularly on the control box, by untrained and unauthorized personnel.

	<p><b>Copyright</b></p> <p>The contents of this document are the intellectual property of Katadyn Group, Kempthal, Switzerland. It may not be adapted by the user of the EK system for his own manufacture, nor on behalf of a Third Party, even under exceptional circumstances, without our written approval. The instruction manual, or parts thereof, may not be reproduced in any way, nor made available to a Third Party.</p>
---	--

## 10 Operating Panel

---



### NOTE

Do not use any metallic or sharp objects to operate the touch screen.  
Avoid excessive pressure when operating the touch screen.

All necessary control operation can be carried out through the Operating Panel Touch Screen.

### 10.1 Start Screen

After switching on the Control Cabinet, the Katadyn "Start" Screen will appear.





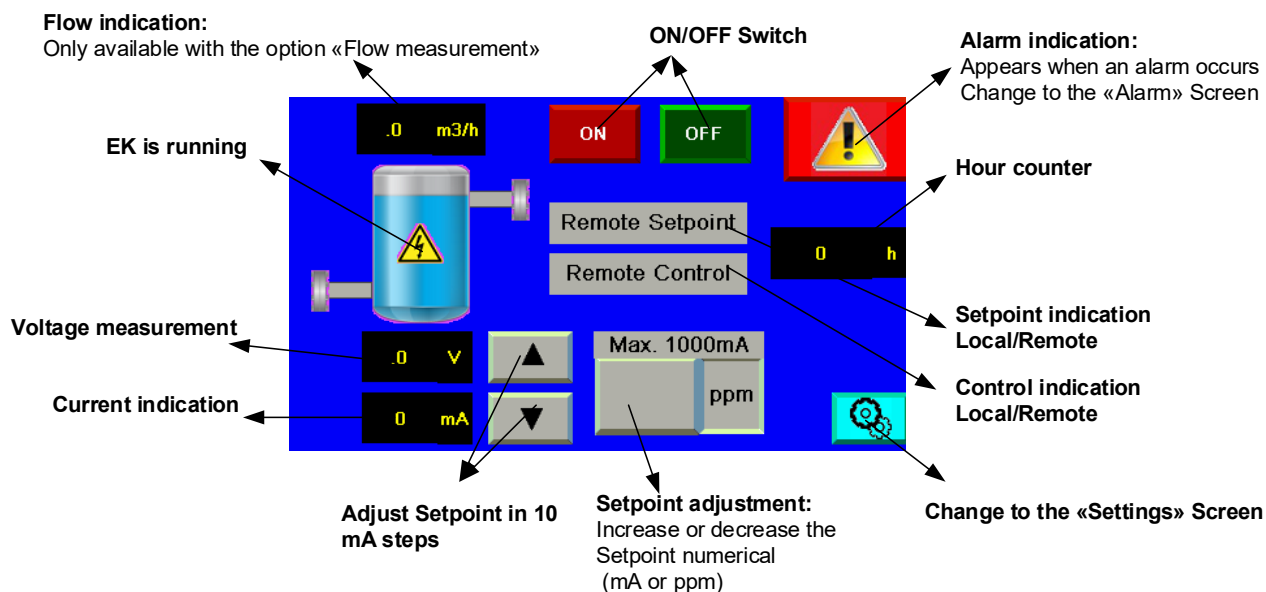

KATADYN GROUP

By touching the Katadyn Logo, the "Overview" Screen will appear.

## 10.2 Overview Screen

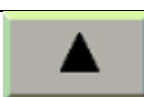
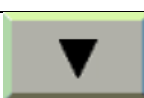
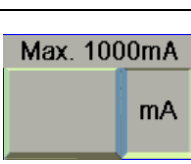

### Switches on the Screen “Overview”

	Switch ON the EK System locally The controller will ramp up the actual value to the Setpoint.
	Switch OFF Locally the EK System.
	Increases the Setpoint in 10mA steps up
	Decreases the Setpoint in 10mA steps down
	Numerical current (mA) Setpoint input. If the option “Flow measurement” is activated and the control is set to ppm, then the required dose* in ppm can be set over the numerical input.
	Change from “Overview” screen to “Setting” screen

\*Dose control is calculated by the law of Faraday: 1 mA= 4mg Ag+/hr







**NOTE**

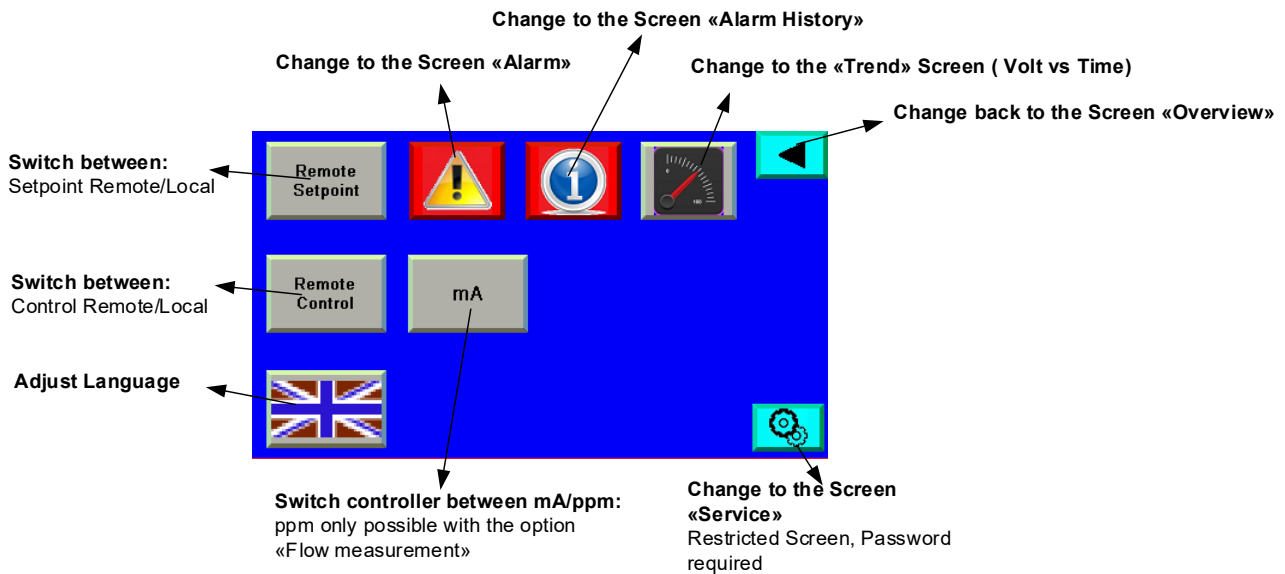

Dose control is based on flow measurement, and the law of Faraday and will help to achieve a flow independent silver concentration in the process flow. Measurements in regular intervals have to be conducted to ensure the correct dosage.

**10.3 Setting Screen**

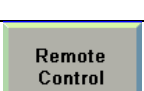
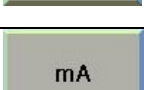

**Switches on the Screen "Setting"**

	Change to the screen "Service" Access only for Katadyn authorized personal.
	Change to the screen "Overview."
	Setpoint switch Local / Remote
	Control switch Local / Remote
	Change from current (mA) to dose control (ppm). <b>ppm control only with option "Flow measurement" possible.</b>
	Language selection (GE, EN, FR)
	Change to the screen "Alarm"





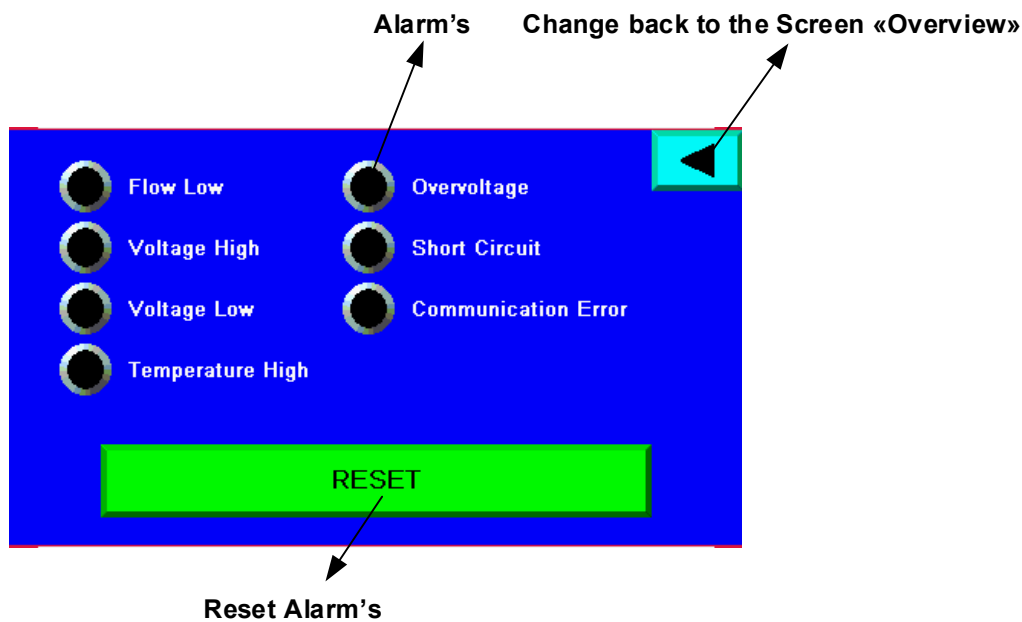

	Change to the screen "Alarm History"
	Change to the screen "Trend"





## 10.4 Alarm Screen



### Alarms

	Flow Low	Flow rate through EK below 0.5 m <sup>3</sup> /h
	Voltage High	Voltage on the Activator is above 21.5 V DC.
	Voltage Low	Voltage on the Activator is below 0.25 V DC.
	Temperature High	Cabinet temperature (internal) is above 45°C
	Overvoltage	Electrical circuit to the Activator is open
	Short Circuit	Short circuit inside of the Activator or the wiring to the Activator
	Communication Error	Connection between PLC and HMI is faulty

### Switches on the Screen "Alarm"

	Change to the screen "Overview."
	Acknowledge all Alarms. Red LED will disappear when no alarms are pending

## 10.5 Alarm History and Trend Screen

**Last 10 Alarm's**

Alarm Message	Occurrence Date
Alarm Message	Occurrence <sup>+</sup>

**Change to the «Settings» Screen**

**Activator Voltage**

**Change to the «Settings» Screen**

## 11 Commissioning of the Electro-Katadyn System EK-4 / EK-24

---

### 11.1 Basic components:

- Control Cabinet
- Activator with electrode system
- Flow Switch

The bypass piping (main pipe) is not part of the Katadyn scope of supply. The bypass (“part-stream”) principle is applied to keep the head loss low and is used in the case of larger flow volumes. The partial flow diverted through the Electro-Katadyn System receives silver ions in proportionately higher concentration. The silver dose needed is reached by subsequent mixing of the water in the common pipe downstream of the Electro-Katadyn. Based on empirical data the following values serve as a guide for expected flows through the EK:

EK 4:            0.5 m<sup>3</sup>/h

EK 2-6/24:    2.0m<sup>3</sup>/h

### 11.2 Environmental conditions

Check if the mounting position corresponds to the environmental data in chapter 8.2 *Environmental data*

### 11.3 Short installing guide of the EK System

- Mount the Activator body to a suitable place
- Mount the Control Cabinet close to the activator body (activator cable length 1.2m)
- Connect the inlet piping to the inlet of the activator (G3/4" EK-4, G1" EK-X/24)
- Connect the outlet piping to the outlet piping of the activator (G3/4" EK-4, G1" EK-X/24)
- Connect the drain piping to the drain outlet of the activator (G3/4" EK-4, G1" EK-X/24)
- Wiring the Flow Switch, activator head, the Mains supply and all other optional instruments to the Control Cabinet (see connection drawings 17.5 Electrical connection / 17.6 Electrical connection Activator Anode/Cathode).
- Remove screws from activator head.
- Remove activator head
  - If silver anodes and cathodes are not installed, install them according chapter 11.4 *Mount the anodes to the activator*
- Check that sealing ring is properly placed on activator head
- Replace activator head on Activator body and screw in the screws (max 4Nm torque)
- Pressurize the whole system and check for leaks.

## 11.4 Mount the anodes to the activator EK-X/24



Before working on the control cabinet or activator, be certain to unplug it from the power socket and wait at least 5 minutes until all components have discharged.

- Screw in all the anodes on the activator head in following order

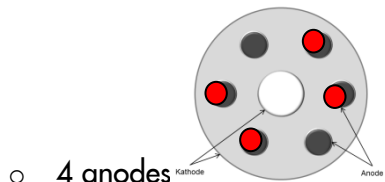
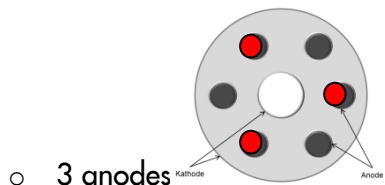
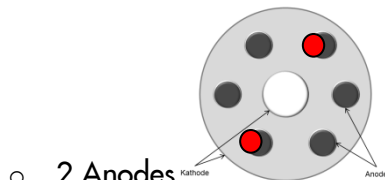

- 6 anodes

- Insert the outer cathode over the anodes and place it flush against the activator head
- Ensure the guide pins are properly aligned with the guide holes in the outer cathode

Make sure, the anodes and the cathodes are mounted accordingly (shown the anode-/cathode-combination of a Type EK 6/24)



View of the inside of the outer cathode without central cathode and anode installed

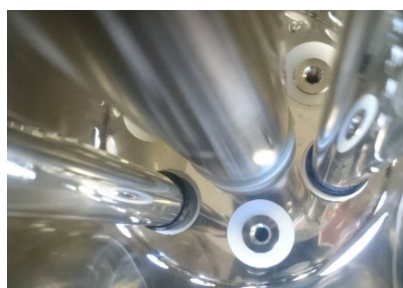

View of the inside of the outer cathode with central cathode and anodes installed

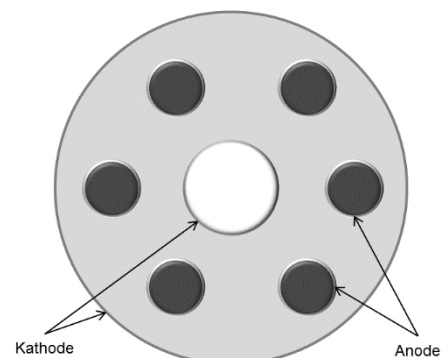



Anodes fitted on to the header without cathodes



The complete header with anodes and cathodes



**NOTE**

When mounting the header to the activator body, tighten the screws crosswise in 3 steps with a torque wrench up to max. 4Nm

**11.5 Insert the anode into the EK-4 activator**

There is only one anode on the EK-4 system. The body of the EK-4 acts as the cathode of the system. The anode is screwed in to the header and then subsequently inserted as one piece into the activator body (cathode) of the EK-4 (see picture below)



Anode

Activator body  
(Cathode)

## 11.6 Water inlet and outlet / drainage



### ATTENTION!

Pipes and pipe fittings must be done according to the local guidelines and by qualified personnel.

The water to be treated enters the EK through the inlet located at the bottom of the activator where the Flow Switch is situated. If the “part-stream” principle is applied, the pipes for water inlet and outlet lead to the main pipe. If the complete water volume is to flow through the Electro-Katadyn unit (= smaller flow rates), the unit is inserted into the main pipe.

The drain port at the bottom of the activator should be connected to a drain pipe. This will allow the water in the activator body to be drained out to allow maintenance work to be carried out on the EK.



Inlet water valve EK-4



Inlet water valve EK-24

## 11.7 Starting the Water Flow

Set valves in the operation position (see illustrations below)

Inlet / drain valve:

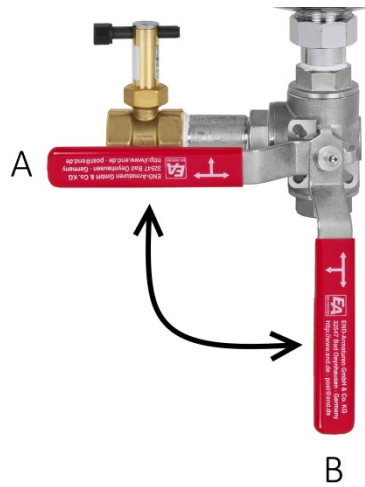

A = Valve opened (Operating position)

B = Valve closed (Draining position)

Outlet valve:



Turn fully left to open the valve (for operation)



Turn fully right to close the valve

## 11.8 Electrical connection



### ATTENTION!

All electrical connections must be done according to the local guidelines and by qualified personnel.

The Control Cabinet is equipped with 2A slow blow fuse inside of the Mains connector. Ensure that the feeding power cable is fused accordingly.

Please see at the attachment (17.5 Electrical connection / 17.6 Electrical connection Activator Anode/Cathode) for the electrical connection possibilities.

## 11.9 Starting the Electrical Control System

Once the power has been correctly connected to the Control Cabinet, the Mains Switch turned on and the Operating Panel is started up, then the Katadyn Logo will appear. By touching the Katadyn Logo the "Overview" Screen will appear.

## 11.10 Current/Dosage adjusting of the EK

The required current for the given silver ion dosage is calculated using Faraday's First Law of Electrolysis.

### Faraday's First Law of Electrolysis

The amount of any substance deposited or liberated during electrolysis is proportional to the quantity of electric charge passed and to the equivalent weight of the substance.



### NOTE



Due to the change in water flow, water quality or dosage need, the effective silver dosage in the water has to be checked after commissioning and the pre-set current of the Control Cabinet may need to be adjusted.



## 11.11 Local Setpoint

**Precondition:** Setpoint must be set to LOCAL on the Screen "Setting".

The amperage (mA) for silver ion (Ag+) dosing can be set on the Screen "Overview" by entering the Setpoint numerical or over the increase/decrease buttons.

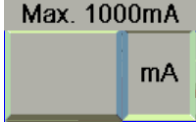
	Increases the Setpoint in 10mA up steps
	Decreases the Setpoint in 10mA down steps
	Numerical current (mA) Setpoint input. If the option "Flow measurement" is activated and the control is set to ppm, then the required dose* in ppm can be set by numerical input.

### 11.11.1 Remote Setpoint

**Precondition:** Setpoint has to be set to REMOTE on the Screen "Setting".



0-10VDC source connected to -X3:18/19/20 (see attachment 17.5 Electrical connection)

The 0-10VDC remote input corresponds to the 15-1000mA output to the activator

### 11.11.2 Dosage control

	<p><b>NOTE</b></p> <p>Dose control is based on flow measurement and the law of Faraday and will help to achieve a flow independent silver concentration in the process flow. Measurements in regular intervals have to be conducted to ensure the correct dosage.</p>
---	---

**Precondition:** Option “Flow measurement” is available (Katadyn Flow Sensor instead of Flow Switch) and connected to -X3:21/22/23 (see attachment 17.5 Electrical connection). Setpoint has to be changed to ppm on the Screen “Setting”.

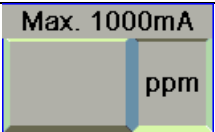

	Change from current (mA) to dose control (ppm). <b>ppm control only with option “Flow measurement” possible.</b>
	Warning indication on the “Overview” Screen if flow rate or dosage is out of range.
	Numerical current (mA) Setpoint input. If the option “Flow measurement” is activated and the control is set to ppm, then the required dose* in ppm can be set over the numerical input.

## 11.12 Start/Stop silver ion (Ag+) production

	<p><b>NOTE</b></p> Ensure that the water flow and the setpoint is in compliance with the required specification.
--	--

### 11.12.1 Start/Stop Local

**Precondition:** Control has to be set to LOCAL on the Screen “Setting.”

	Switch ON the EK System locally The controller will ramp up the actual value to the Setpoint.
	Switch OFF locally the EK System.

### 11.12.2 Start/Stop Remote

**Precondition:** Control has to be set to REMOTE on the Screen “Setting”

Potential free contact connected to -X3:14/15 (see attachment 17.5 Electrical connection)

Close the contact to start the system remotely.

## 12 Installation options of EK systems

There are different options to install the EK system to an existing water pipe system.

Because the diameter of the tubes from the EK system is limited to 1", the Electro Katadyn is installed as a bypass device:

### 12.1 Sample System Layout *bypass*

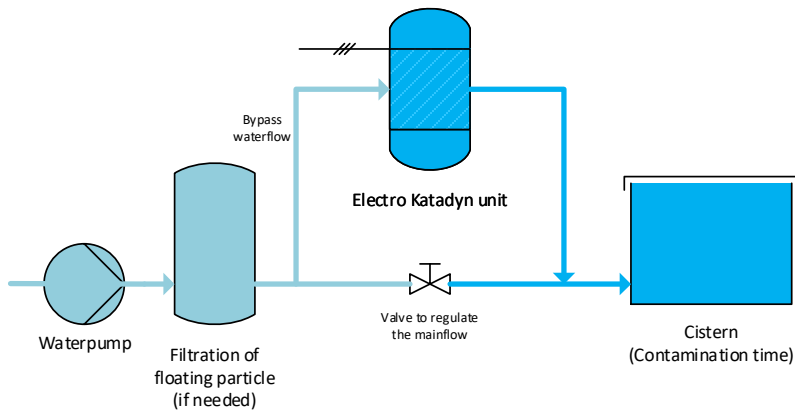

### 12.2 Sample System Layout *marine*

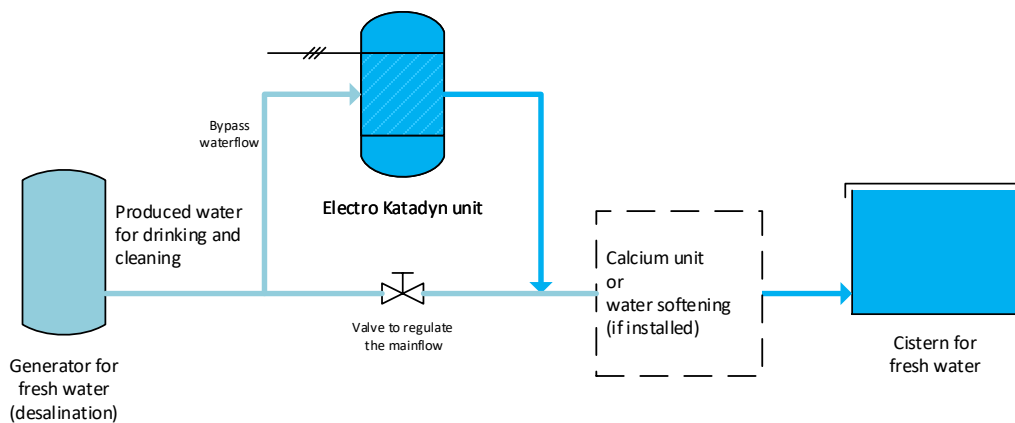

### 12.3 Sample System Layout without bypass using direct flow *marine*

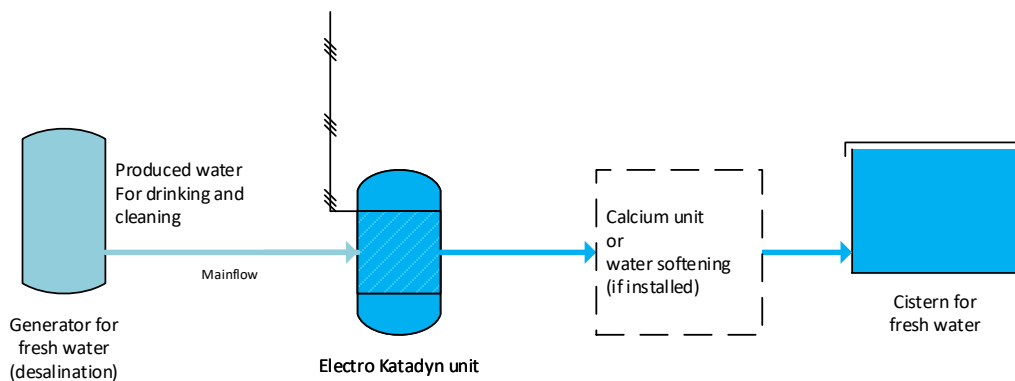

## 12.4 Sample P&I Layout *bypass* with automatic valves and flow measurement



### NOTE

Valves and flow measurement are not included in the standard delivery from Katadyn. The flow measurement can be ordered as an option.

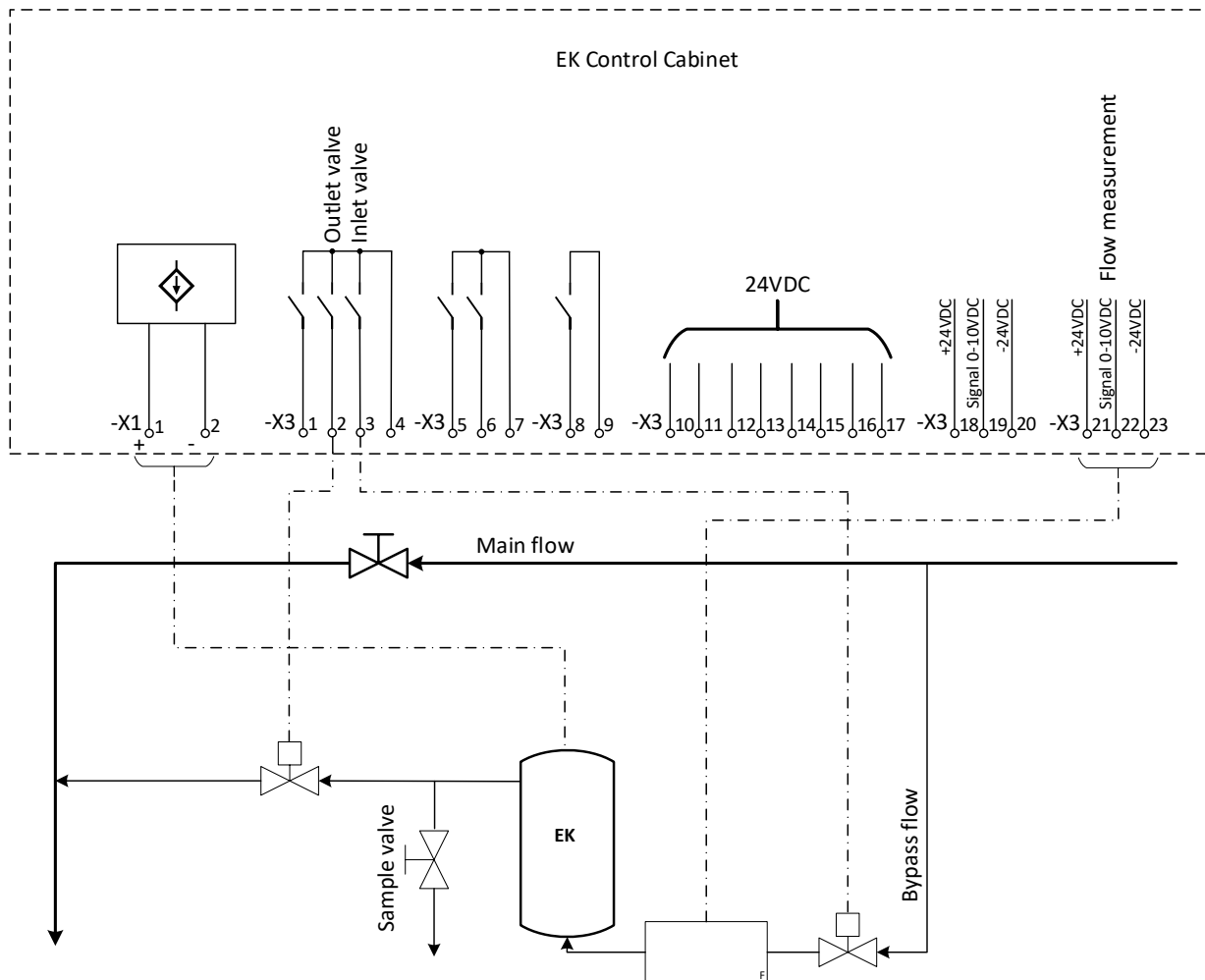

### 13 The conductivity of the water

---

Conductivity is a measure of water's capability to pass electrical flow. This ability is directly related to the concentration of ions in the water. These conductive ions come from dissolved salts and inorganic materials such as alkalis, chlorides, sulphides and carbonate compounds. Compounds that dissolve into ions are also known as electrolytes. The more ions that are present, the higher the conductivity of water. Likewise, the fewer ions that are in the water, the less conductive it is. Distilled or deionized water can act as an insulator due to its very low (perhaps negligible) conductivity value.

Conductivity drinking water 100 to 500  $\mu\text{S}/\text{cm}$

Distilled or deionized water 0.5 to 5  $\mu\text{S}/\text{cm}$

If the EK-X/24 is to be installed in a low conductivity application (see chapter 8 Technical data), the flowrate of produced water will be very much lower compared to normal drinking water and different sized cathodes will be required consisting of a central cathode with a larger diameter (50mm) and an outer cathode with a smaller diameter (110mm). This results in a reduction of the distance between the electrodes that an electrical current needs to pass through.

## 14 Monitoring and Maintenance



### NOTE

Check periodically whether amperage, visible on the Touch Screen, corresponds to the calculated value for the expected Ag+ dosage.

### 14.1 Basic Maintenance

Once everything is properly set, handling is restricted to an occasional check of the milliamps (mA) setting and the periodic cleaning of the electrode system.

Retighten all terminals once per year.

**NOTE:** At 0.05 ppm (50 ppb) silver dose, each anode can treat approximately 4'000m<sup>3</sup> of water  
 At 0.02 ppm (20 ppb) silver dose, each anode can treat approximately 10'000m<sup>3</sup> of water



### NOTE

Only use original spare parts which are listed in the attached spare parts list.

### 14.2 Checking the Effect

The silver concentration in the water may be analyzed regularly with appropriate measurement tools. Samples to be taken at the sampling tap as well as at the final point of use (tap, bottling point, etc.)

Testing methods:

1. Silver ion test kits: simple to use however not very accurate. Useful just to test if there are actually silver ions in the water
2. Colorimetric method or Ion Selective Electrode: This uses a handheld analyzer. Highly accurate. Can measure down to 0.01 ppm
3. Laboratory test using mass spectrometry: Very accurate

### 14.3 Cleaning the Electrode System



### NOTE

Clean the electrode system in activator every 50 hours of operation and more often with harder water.

This has to be done periodically. The frequency depends on the contents of minerals in the water. Generally, cleaning is recommended after about 50 hours of operation.

To clean the electrode system, proceed as follows:

- a) Disconnect the power to the Electro-Katadyn-System (Control box and activator)
- b) Close the inlet/drain valve to drain activator (switch from position A to B)

Close the inlet/drain valve:

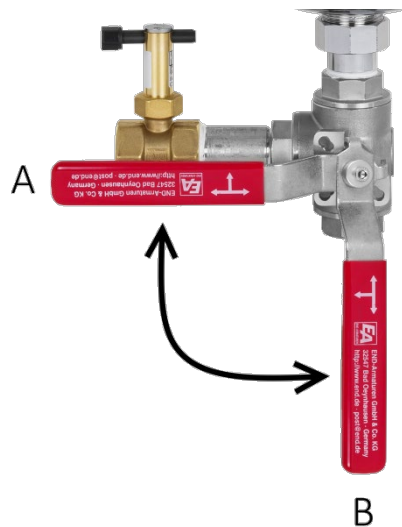

Position A: Opened valve

Position B: Closed valve

c) Close the outlet valve.

Outlet Valve:



Turn left to open



Turn right to close

- d) Loosen captive screws of activator lid.
- e) Lift out the activator head with the electrodes.
- f) Unscrew the central cathode and remove outer steel cylinder.
- g) Clean electrodes (anodes/cathodes) by brushing them lightly. Use no hard tools.

If the deposits cannot be removed by brushing, place the parts in a 3 - 5% solution of hydrochloric acid, which will dissolve the deposits



**CAUTION**

Wear gloves when working with hydrochloric acid.

After rinsing with water, reassemble the activator by reversing the steps listed above.

## 15 Troubleshooting

	<p><b>ELECTRIC SHOCK!</b></p> <p>Switch off the Mains Switch and disconnect the Mains connection (230/120VAC) before conducting any work on the Elektro Katadyn System.</p>
---	---

### 15.1 Flow Low

	Flow Low	Flow rate through EK below 0.5 m <sup>3</sup> /h
---	----------	--

- Check if water is available
- Check if the inlet and outlet valves are open
- Check if there is any restriction in the pipe system
- Check if the Flow Switch is wired correctly
- Check if there are any mechanical damages to the Flow Switch

### 15.2 Voltage High

	Voltage High	Voltage on the Activator is above 21.5 V DC.
--	--------------	--

- Check if there is an open circuit form the Control Cabinet to the Activator
- Check if the Anode(s) is (are) used up. No silver visible on the anode
- Check if the conductivity of the water is according to the technical data in chapter 8

### 15.3 Voltage Low

	Voltage Low	Voltage on the Activator is below 0.25 V DC.
---	-------------	--

- Check if there is an short circuit form the Control Cabinet to the Activator
- Check if the current setting is correct
- Check if the conductivity of the water is according to the technical data in chapter 8

### 15.4 Temperature High

	Temperature High	Cabinet temperature (internal) is above 45°C
---	------------------	--

- Check if the Temperature Switch inside the Control Cabinet is set to 45°C
- Check to verify if ambient temperature is ≤ 40°C

### 15.5 Overvoltage

	Overvoltage	Electrical circuit to the Activator is open
---	-------------	---

- Check if there is an open circuit form the Control Cabinet to the Activator
- Check if the conductivity of the water is according to the technical data in chapter 8



## 15.6 Short Circuit

	Short Circuit	Short circuit inside of the Activator or the wiring to the Activator
---	---------------	--

- Check if there is an short circuit form the Control Cabinet to the Activator or inside the Activator

## 15.7 Communication Error

	Communication Error	Connection between PLC and HMI is faulty
---	---------------------	--

- Check if the PLC is running without any fault (red LED) indication
- Check the connection between PLC and HMI
- Restart the PLC → Mains Switch OFF/ON

## 16 Packaging and Transport

---



**NOTE**

The EK devices must be professionally packed and protected against moisture, mechanical damage, vibration, direct sun, dirt and dust.

Ensure that qualified personal and suitable lifting equipment are used to load and unload the equipment.

## 17 Appendix

### 17.1 Spare Parts for Electro Katadyn EK-4

Item No.	Quantity	Description of Components	Specifications
37000	1	Anode	E-1
14404	1	Flow Switch	R 3/4"

### 17.2 Spare Parts for Electro Katadyn EK 2-6/24

Item No.	Quantity	Description of Components	Specifications
37000	2 – 6	Anodes	E-1
39614	1	Central cathode	Ø 40 mm
86012	1	Outer cathode	Ø 120 mm
7010717	1	Central cathode for low conductivity	Ø 50 mm
7012112	1	Outer cathode for low conductivity	Ø 110 mm
141802	1	Seal for activator lid	Ø 160 mm
141681	1	Flow Switch	1"
141804	1	Inlet-3-way-valve	1"
141803	1	Outlet hand valve	1"
8020546	1	LED Driver	-G1

**17.3 Dimensions EK 4**

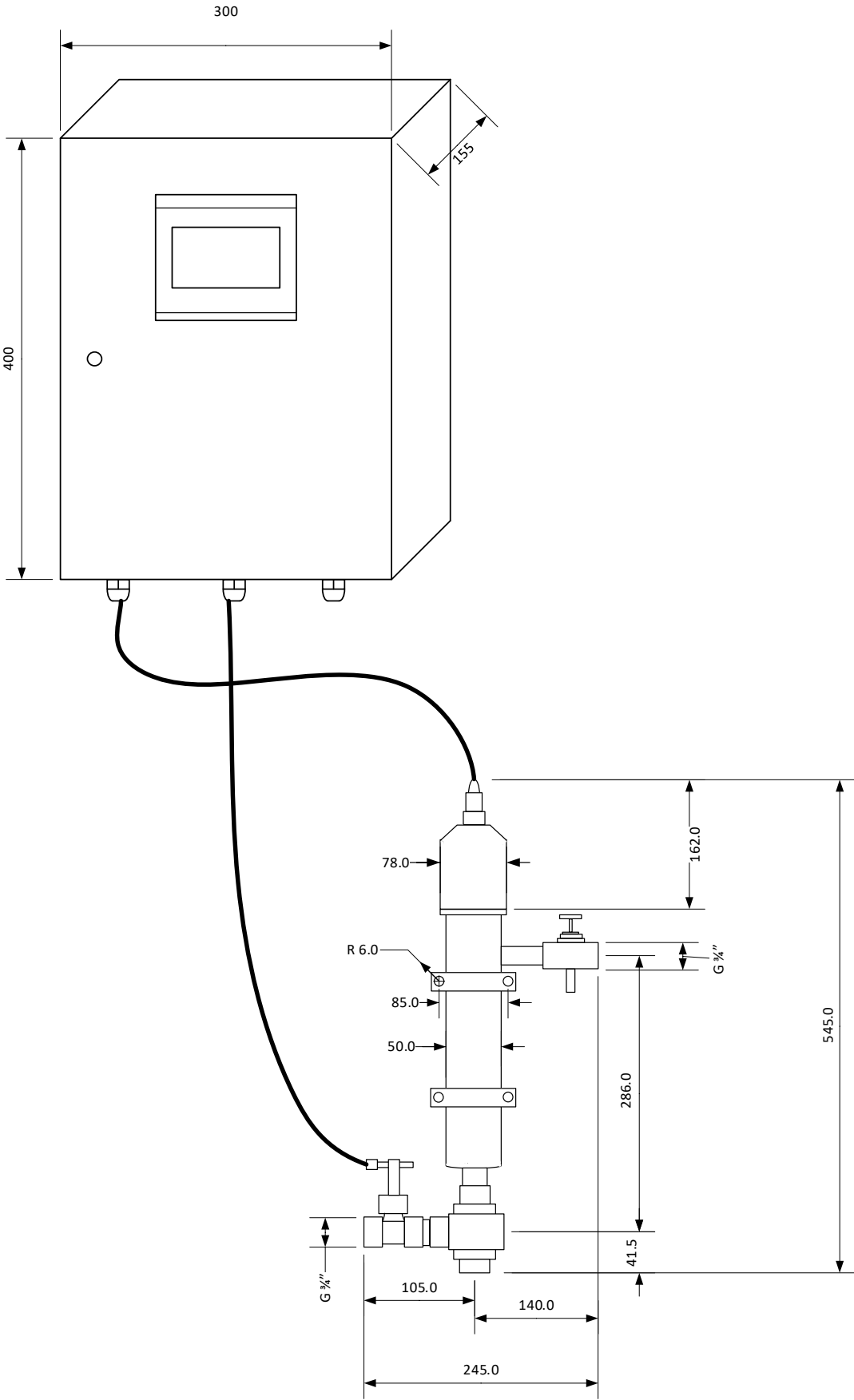

### 17.4 Dimensions EK 24

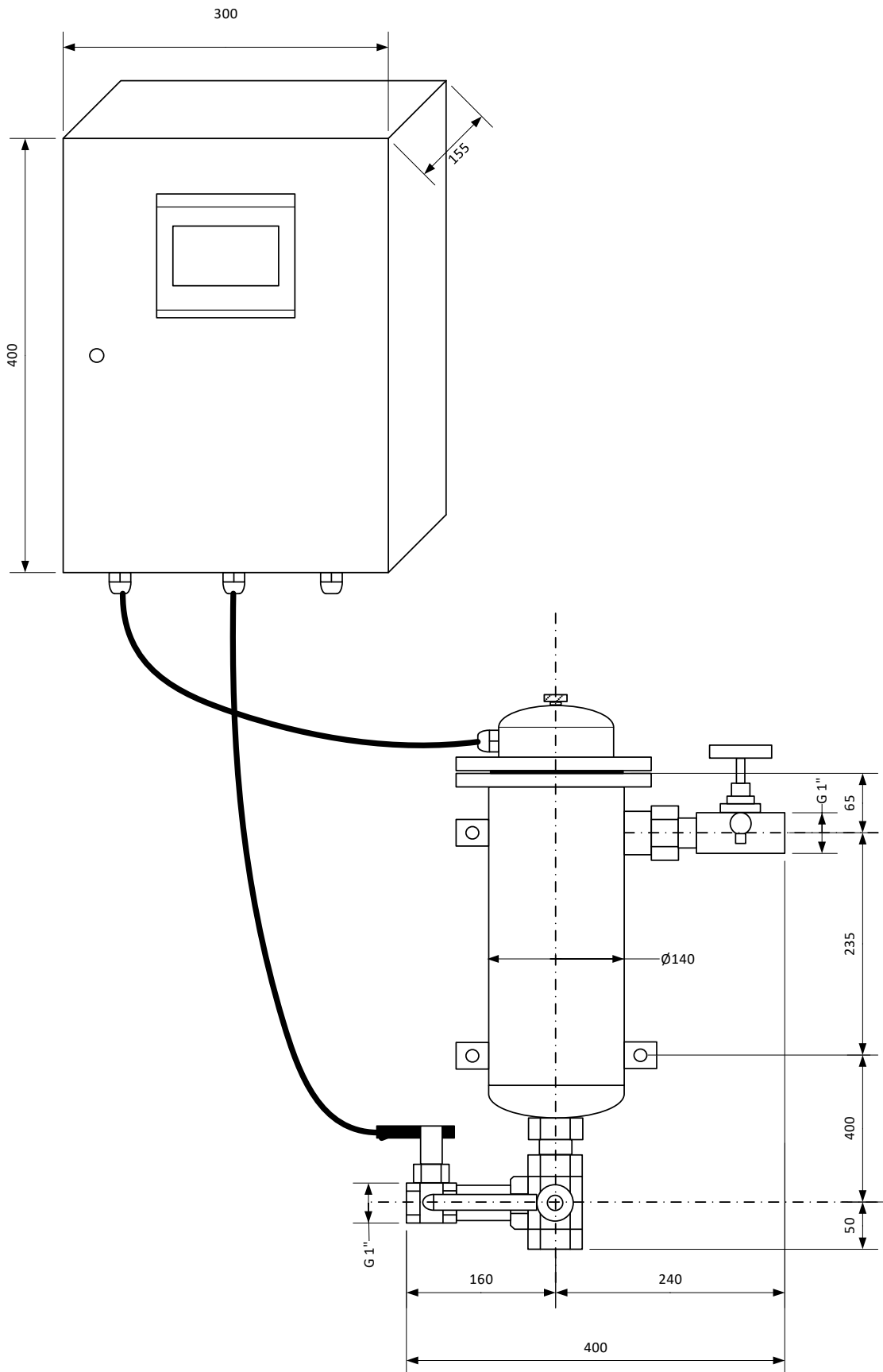

## 17.5 Electrical connection

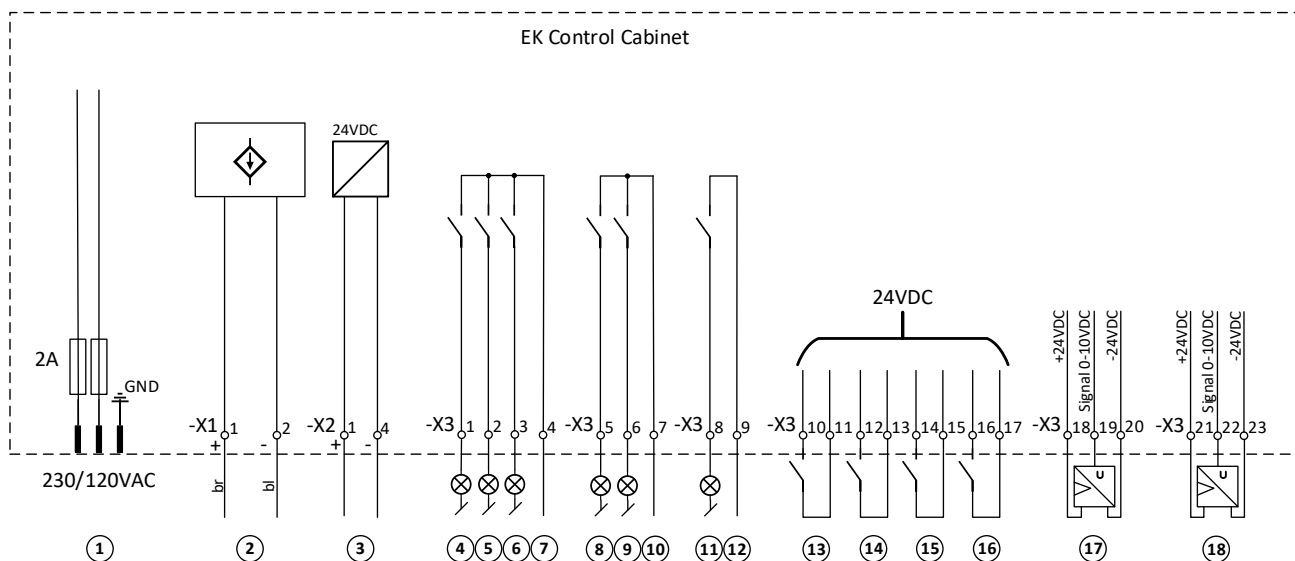

1	Incoming power Mains connector	220/120VAC
2	Output to activator (Anode +brown, Cathode - blue)*	30VDC/1000mA
3	Auxiliary Power Supply for instruments & sensors	24VDC/0.5A
4	Spare	Contact closed (max. 2A)
5	Outlet valve ON/OFF	Contact closed (max. 2A)
6	Inlet valve ON/OFF	Contact closed (max. 2A)
7	Supply Voltage for 4/5/6	240VAC/24VDC
8	Ext. Cooling ON/OFF	Contact closed (max. 2A)
9	Alarm	Contact closed (max. 2A)
10	Supply Voltage for 8/9	240VAC/24VDC
11	EK Running	Contact closed (max. 2A)
12	Supply Voltage for 11	240VAC/24VDC
13	Spare (24VDC supply from control cabinet)	Contact closed
14	Remote Reset (24VDC supply from control cabinet)	Contact closed
15	Remote ON (24VDC supply from control cabinet)	Contact closed

16	Flow Low Switch (24VDC supply from control cabinet)*	Contact closed
17	Setpoint Remote 0-100 %	0-10VDC
18	Water Flow 0-4.8 m <sup>3</sup> /h	0-10VDC

\*Mandatory connections

## 17.6 Electrical connection Activator Anode/Cathode

### 17.6.1 EK-4

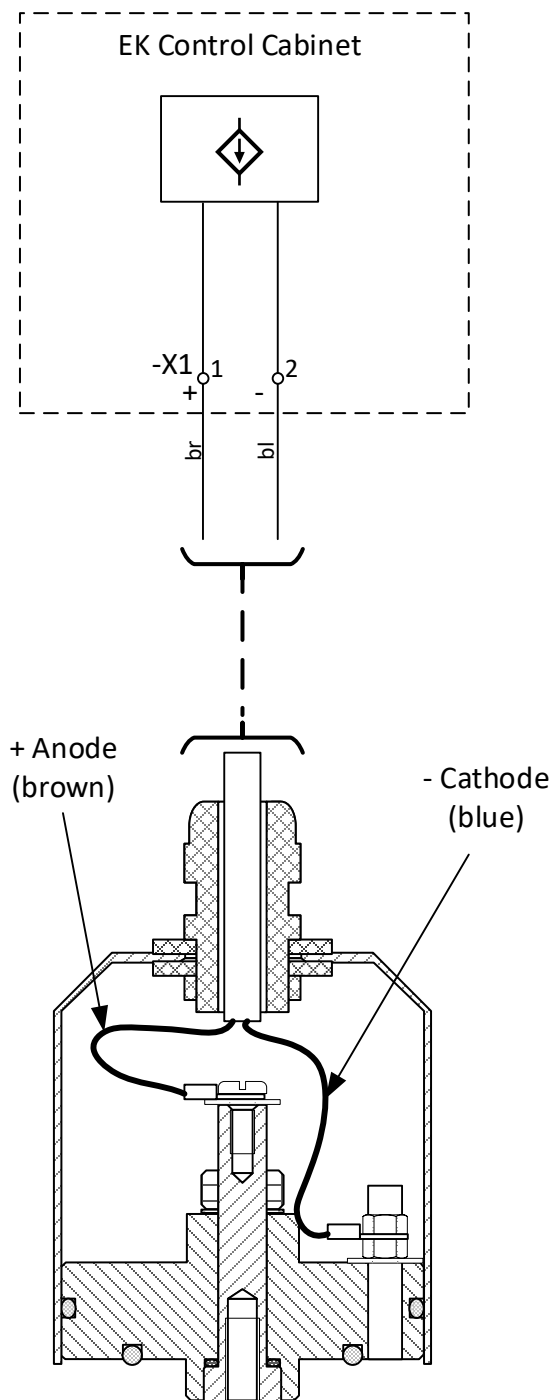



17.6.2 EK-24

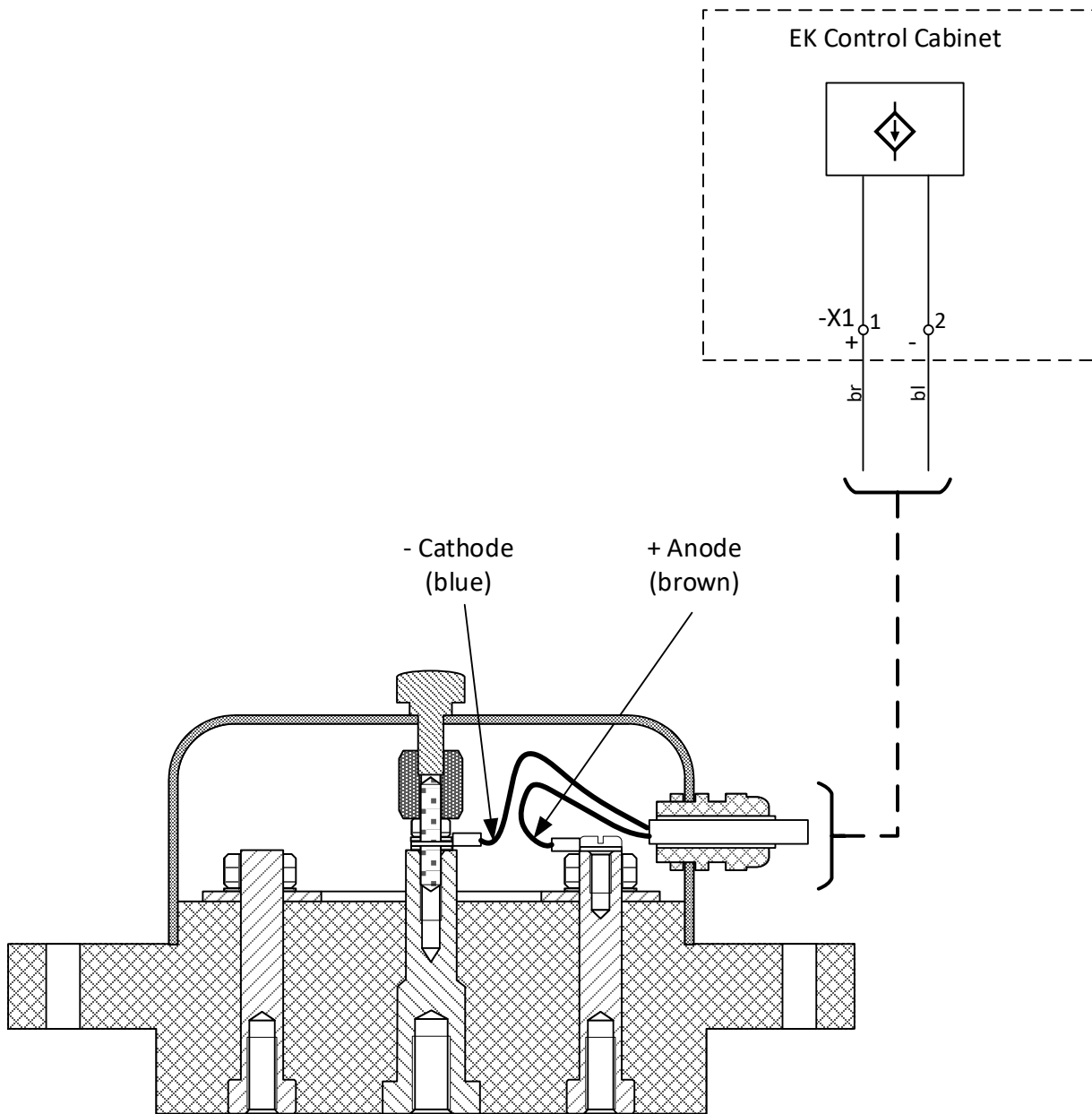

## 18 CE declaration of conformity



### CE Konformitätserklärung CE declaration of conformity



<b>Anlagen-Typen:</b> <i>Unit types:</i>	<b>EK 2/24 / EK 3/24</b> <b>EK 4/24 / EK 6/24</b> <b>EK-4</b>	<b>Produktbezeichnung:</b> <i>Product-name:</i>	<b>Elektro Katadyn</b> <i>Electro Katadyn</i>
---	---	--	--

**Wir erklären, dass die vorgenannten Produkte hinsichtlich ihrer Entwicklung, Herstellung und angewendeten Testprozeduren, den grundlegenden Sicherheits- und Gesundheitsanforderungen den nachfolgend aufgeführten Richtlinien entsprechen:**

*We herewith confirm, that the above-mentioned products are in compliance with the below mentioned directives of the European Community. Design, manufacturing and applied test procedures followed the guiding rules / regulations as stated below in order to fulfil the general safety and health requirements of the EU:*

**Richtlinie 2014/35/EU**  
*Directive 2014/35/EEC*

**Niederspannungsrichtlinie**  
*Low voltage directive*

**Richtlinie 2014/30/EU**  
*Directive 2014/30/EEC*

**EMV-Richtlinie**  
*EMC directive*

**Risikobeurteilung nach EN ISO 12100**  
*Risk assessment according EN ISO 12100*

**Harmonisierte Normen**  
*Harmonized standards*

<b>EN55011+A1</b>	<b>EN 60529</b>
<b>EN 61000-6-1</b>	
<b>EN 61000-2</b>	
<b>IEC/EN 61000-4-2</b>	
<b>IEC/EN 61000-4-4</b>	
<b>IEC/EN 61000-4-5</b>	

**Eine technische Dokumentation ist vollständig vorhanden. Eine zum Produkt gehörende Betriebsanleitung liegt in den Sprachen deutsch (Original) und englisch (als Übersetzung) vor.**

*A full technical documentation is available. The operating manual is available in German (original) and English (as translation).*

Kemptthal, 24.10.2018

Reto Merz

Ort / Datum *Location / Date*

Unterschrift / *Signature*

© 2018 by Katadyn Products Inc.

Katadyn Products Inc.  
Pfäffikerstrasse 37  
8310 Kemptthal /Schweiz  
Tel +41 44 839 21 11 | Fax +41 44 839 21 99  
[info@katadyn.ch](mailto:info@katadyn.ch) | [www.katadyngroup.com](http://www.katadyngroup.com)

**Katadyn Products Inc.**

Pfäffikerstrasse 37 | 8310 Kempthal, Switzerland

Tel: +41 44 839 21 47 | Fax: +41 44 839 21 11

info@katadyn.com [www.katadyn.com](http://www.katadyn.com)