



Aquifer 200 Power Pack Solar Operation Manual



Katadyn Desalination, LLC
Spectra Watermakers
PH 415.526.2780
FX 415.526.2787
www.spectrawatermakers.com
Revised 10.28.21

Table of Contents

Installation	<u>Page Number</u>
Getting Started.....	4
Introduction	5
Feed Water Path	6
Product Water Path	7
Setting Up the Aquifer	8
Electrical.....	9
Operation	
New Systems Start Up and Testing.....	11
Normal Operation	12
Maintenance	13
Service & Maintenance	
Short Term Storage Procedures.....	15
Introduction to Spectra Chemicals.....	16
Long Term Storage	17
Winterizing.....	18
Membrane Cleaning.....	19
Suggested Spares	20
Troubleshooting.....	21
Poor Water Quality	22
Flow Test	23
Service Bulletins	25-29
Plastic Tube Fitting Instructions.....	30
High Pressure Tube Fitting Assembly Instructions.....	31
Parts breakdown for Aquifer systems	32-38

Getting Started

Unpack the system and inspect it to make sure that it has not been damaged in shipment.

Refer to the shipping list for your system to make sure you have received all of the components listed. Do not discard any packaging until you have found and identified all of the parts. The small installation parts are listed on the kit list.

Warning! Spectra Watermakers will not be held responsible for shortages and or freight damage that are not reported within thirty days of the ship date.

Study the system layout diagram, component photos and descriptions before beginning your installation. This will assist you in understanding the function of each component.

Aquifer Shipping List

- Aquifer Portable Watermaker in Pelican Case
- Hand held Salinity monitor
- Suction hose (25') with strainer and Banjo connector
- Brine discharge hose (25') with Banjo connector
- 1/4 product hose (15')



Introduction to the Aquifer 200 PPS

Originally developed for ocean voyaging yachts, the **Spectra Aquifer 200 Portable Watermaker** is both a desalinator and a water purifier. It is capable of producing high quality, good tasting drinking water from virtually any feed water source including ocean, rivers, lakes, or brackish wells. It will effectively separate out salts, organic chemicals, insecticides and pesticides, parasites and their cysts, bacteria, and viruses. It does not remove non-ionized heavy metals or gases.

The watermaker pumps approximately 1.5 gallons (6 liters) of feed water per minute to the reverse osmosis membrane and ten percent of this water passes through the membrane as purified product water and the remaining water is returned to the feed water source as slightly concentrated brine. The brine contains whatever was in the feed water with 10% of the fresh water removed.

Feed water is filtered using a three-stage process. A strainer first keeps out large debris, and keeps the suction hose several inches off the bottom, then the water passes through an 80 mesh screen, then a 5 micron pre-filter protects the Clark pump from silt, algae and abrasive particles before water goes through the membrane and is separated into pure fresh water and the brine discharge .

Aquifer Power Pack is equipped with a battery, solar charge control and an AC power supply that will charge the battery when connected to any AC source (100-300vac). The system also comes with a collapsible solar panel that will run the unit as long as there is direct sunlight.

If the battery is fresh and fully charged the watermaker can be operated directly from the battery for two or more hours without an external power source.

In order to prevent damage to the watermaker, the feed water should never contain chlorine, bleach, or any other strong oxidizer, which will damage the membrane. The watermaker should never be used with feed water saltier than sea water, such as is found in the Great Salt Lake, as operating pressures will be too high. Oil in the feed water will also damage the membrane.

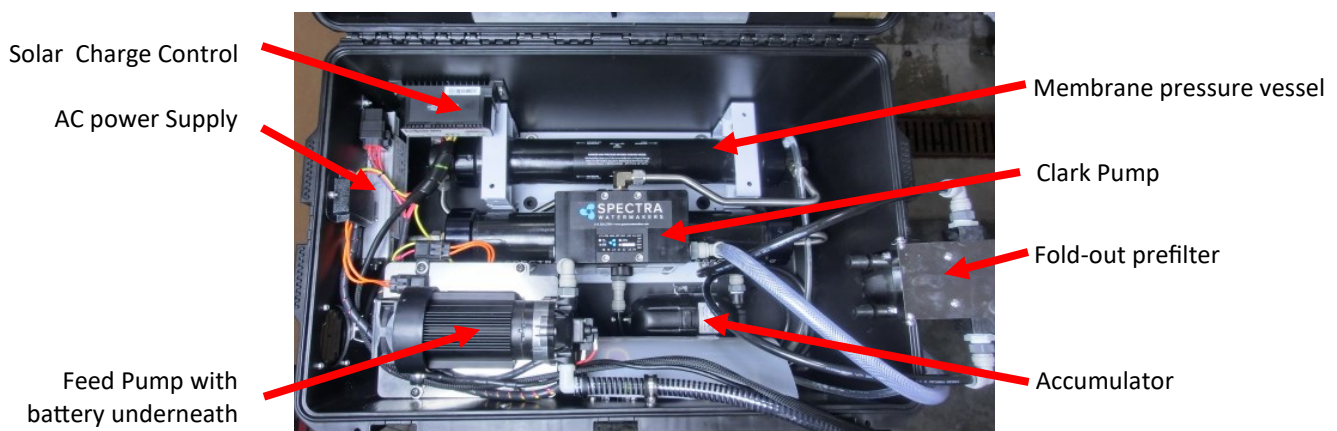

Product Water Path

Product Outlet.

Make sure that there is no restriction in the product line. The hose should be filling vessels or a tank through an air gap. Do not plumb this hose into the bottom of a tank, allow the water to fall into the top of the tank. **Pressure in the product tubing must never exceed 5psi (0.3bar)** at any time, (running or stopped) or the membrane will be permanently damaged.

Clear product water tubing with quick-connect



Product Flow meter

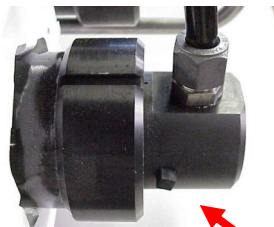

There are four (1/8" NPT) product water ports (2 in each end cap)

Aquifer 200 Feed Water Path

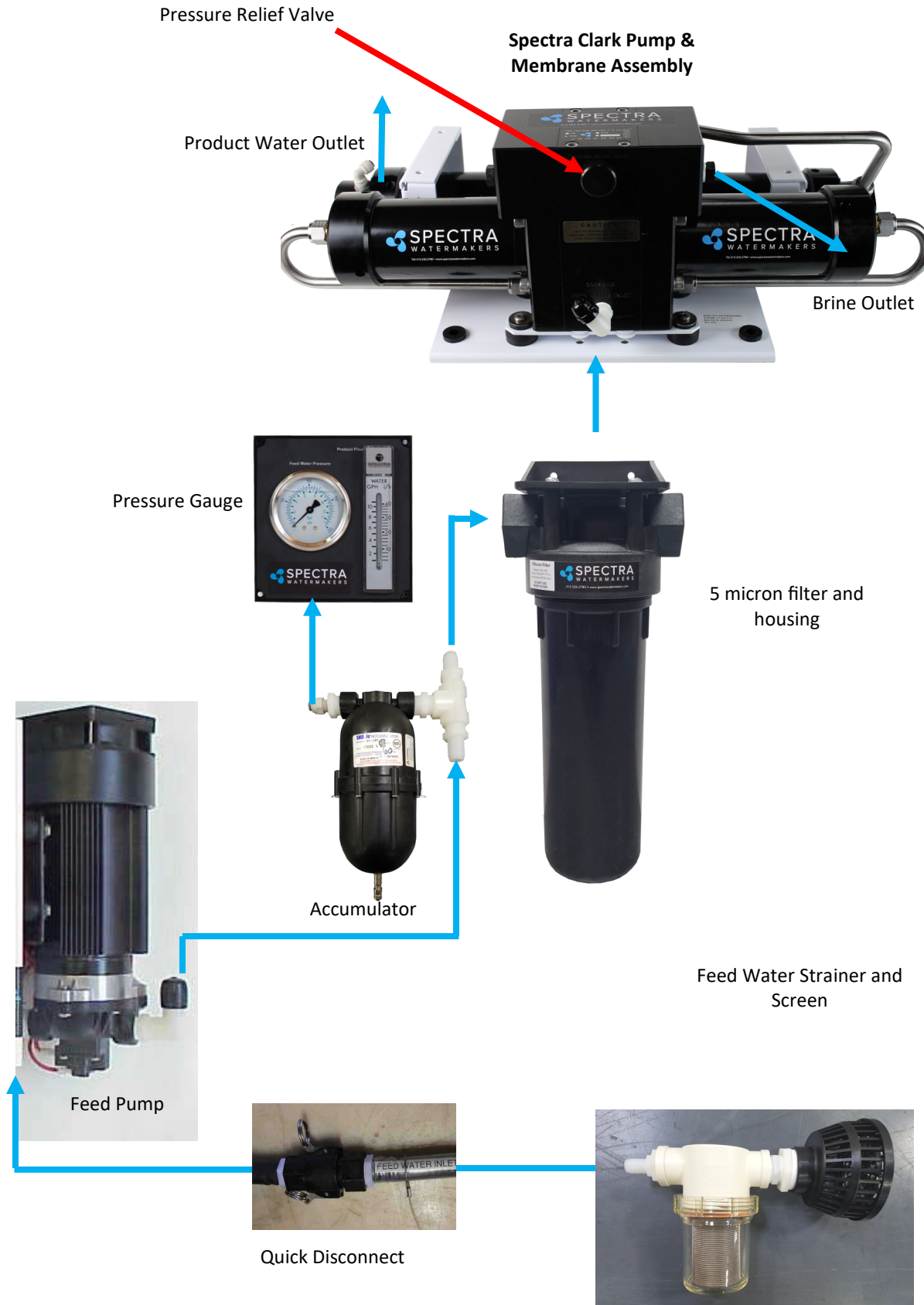

SETTING UP THE AQUIFER

CHOOSING A SITE

Your water source should be as free of suspended sand, silt, algae etc., as possible for longer prefilter life. If making water from a bay, lake, or stream choose a location as deep as possible. Avoid areas with surf or chop. The Aquifer Feed Pump is capable of lifting the feed water not more than 10 vertical feet. When setting up the watermaker choose a spot as near the water as possible, but do not place the case in the water. It is better to run a long extension cord from your power source than to run long hoses to the feed water source. When making water on a sand beach a small pit can often be dug in the sand which will fill with clean water. The water flowing into the pit can be used as feed water and the water will be quite clean after the system has been running for a short time.

SETTING UP

Note: When connecting the suction hose Quick Connect fittings be sure they are clean and free of sand or debris so the seals on the fittings are not damaged! The flat end of the male fitting seals against the flat rubber seal inside the female fitting so both surfaces need to be clean.

Using the quick connect fittings attach the three hoses: Suction hose with strainer and filter basket, brine discharge, and product hose.

You can run the system (**as shown below**) into a bucket to check operation. In this case the stub hoses will be long enough to reach the bucket without attaching the hose extensions. This is also the process used for cleaning or storage solution. When fresh water flushing the system the black spiral suction hose is used to draw in the flush water.

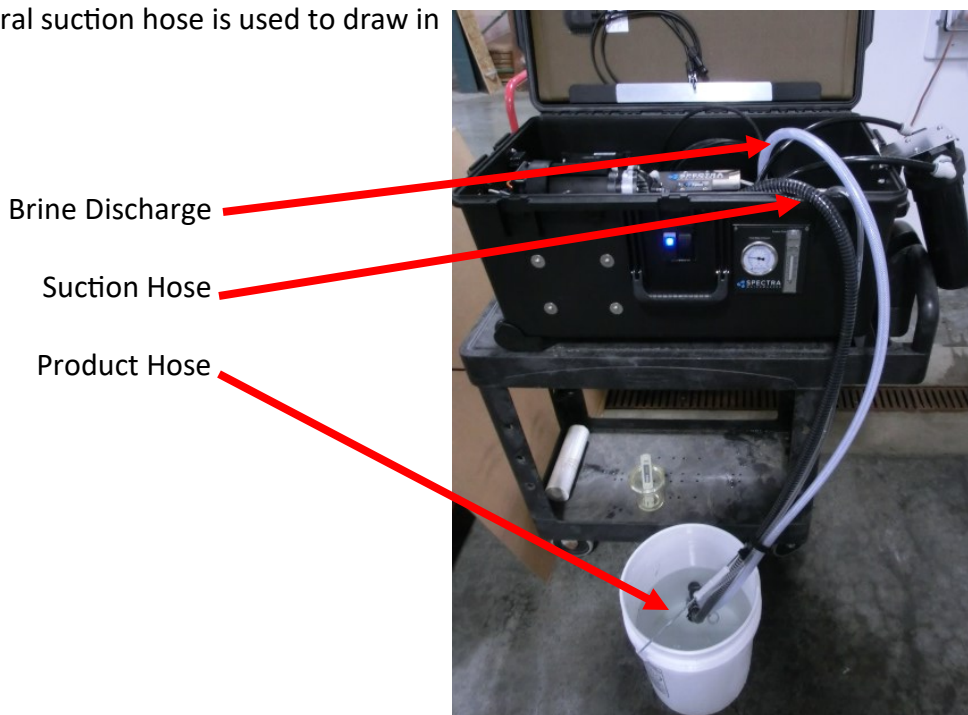

Electrical

The AC power supply accepts input voltages from 100-300 Volts AC, 50/60Hz. Connector supplied is for US-style 110V AC. Other connectors may be attached to the input connector. The AC power supply charges the battery through the Solar Controller. To charge the battery or run the system on AC power just plug it into an outlet and turn on the main power switch. The battery is not connected if the MAIN POWER switch is off.

There are two 15A fuses, one for the battery and one for the pump.

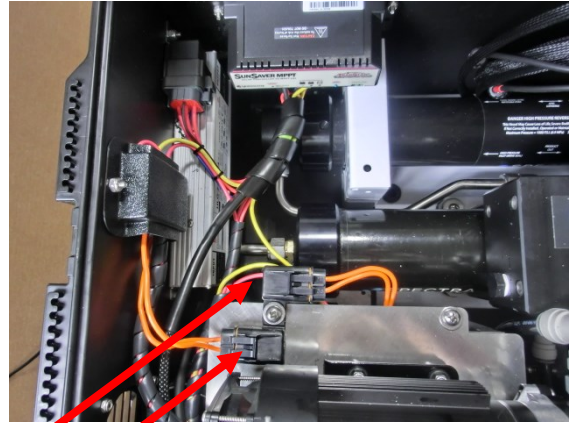

Battery Fuse Holder

Pump Fuse Holder

Note: Unit is shipped with the 15A bBattery Fuse and 15A Pump Fuse removed. These must be inserted into their respective fuse holders before operating your Aquifer 200 Power Pack Solar. See below for assistance.

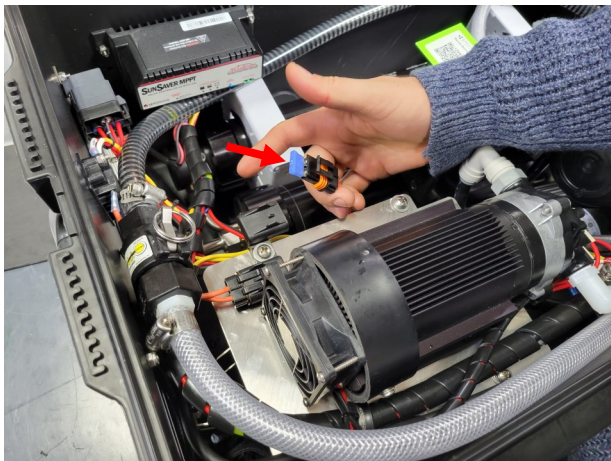

Insert the Battery Fuse

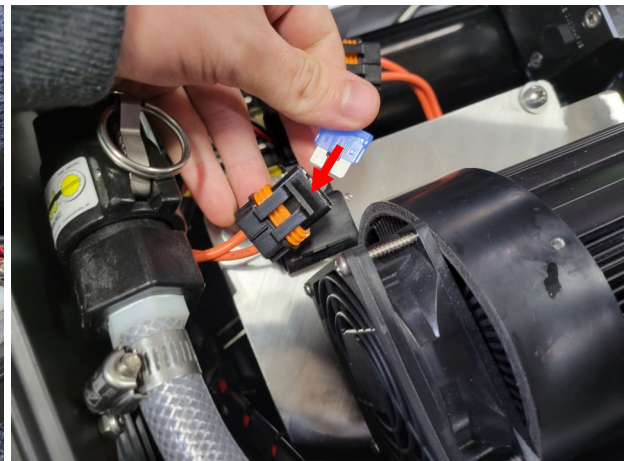

Insert the Pump Fuse

Electrical - Cont.

For purchased Solar Power Pack models only, the included Solar panel fits into the lid of the case. Unfold and connected to the cables in the case.

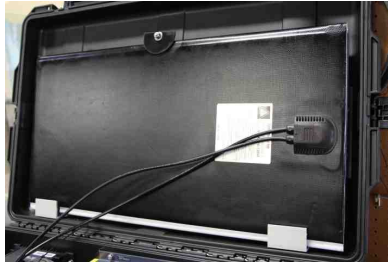

The Solar Power connectors are unique and they will only connect one way.

The Solar Charge Controller will show when the battery is charging (the green light flashes) and the level of battery charge.

The battery must be fully charged for storage.



Note that the Main Power switch must be on for the battery to charge or for the system to operate. The power switch may blink if it is not turned on and power is connected.

The pump is controlled by the switch on the right.

Both lights must be off for storage or the battery will lose it's charge.



Aquifer New System Start-Up and Testing

Warning! Your watermaker shipped from the factory with a non-toxic potable water system preservative. **Damage may occur if this preservative is not flushed out and the membrane is pressurized with preservative in it.**

DO NOT OPERATE the Aquifer system if the feed water could contain oil.

1. Locate an unchlorinated water source. **If the water has been chlorinated or chemically treated, replace the 5 micron filter with a Charcoal Filter element .**
 - Place the strainer end of the Feed Water Hose into the feed water source far enough below the surface to prevent air from being pulled in. Place the end of the brine hose at least 2 meters (6 ft.) away so that the brine does not mix directly back in with the feed water.
 - Attach the product hose and place the end of it so that any product will drain on the ground (with the system unpressurized the amount of product during the flush will be small)
 - **Ensure that the pressure relief valve is open 1 turn.**
 - Plug in the AC power cord, connect solar panel, or ensure that the battery is fully charged.

Remove Tag and split washer



Open one turn to Purge Preservative

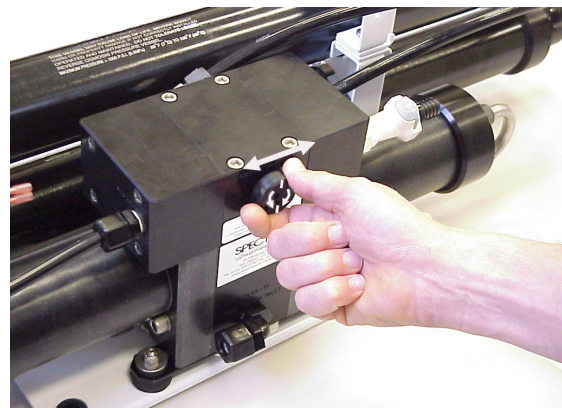

2. Turn on the pump and check that it is primed by inspecting the brine discharge. About 1.5 gpm (6 lpm) of water should be being discharged with a pulsation every few seconds.

3. Run the system without pressure for 20 minutes to purge the storage chemicals **(4-6 hours if stored for an extended period with propylene glycol)**. The system should have an open flow pressure on the gauge of about 20 PSI (1.2 bar). Water may drip from the product tube.

4. Close the pressure relief valve. The pressure should rise to 60-80 PSI (4.2-5.7 bar) if the feed water is sea water. If the feed water is brackish or fresh the pressure will be lower. After several minutes, water should begin to flow out of the product water tube.

5. Allow the system to run for 5-10 minutes to purge the product water of preservative, and then test the product with your handheld salinity tester. When the product is below 750 PPM it is considered potable and may be diverted to the water container for human consumption.

Aquifer Operation

Normal Operation From a Large Body of Water

If the system has been pickled or stored or contains cleaning compounds, use the “New System Startup” procedure.

1. Any source of oil-free feed water not saltier than sea water may be used. Do not use water containing large amounts of heavy metals, such as mine tailing runoff.
2. Place the intake strainer and screen in the feed water source and the brine discharge hose at least 2 meters (6ft.) away from it. Connect the product tube so you are prepared to collect it (let the first 5 minutes of product water run onto the ground).
3. Open the pressure relief valve 1 full turn and start the feed pump. When there is good flow and no bubbles in the brine discharge close the valve.
4. After 5 minutes check the product water with your handheld salinity tester. When it is below 750 ppm the water is good to drink and you may begin to fill containers.
5. Run the system until you have filled your container or have made enough to meet your requirements and 10 liters (3 gallons) for flushing.
6. Make a note of the feed pressure with a clean filter element and change the filter when the pressure rises more than 5 psi (0.3 bar).

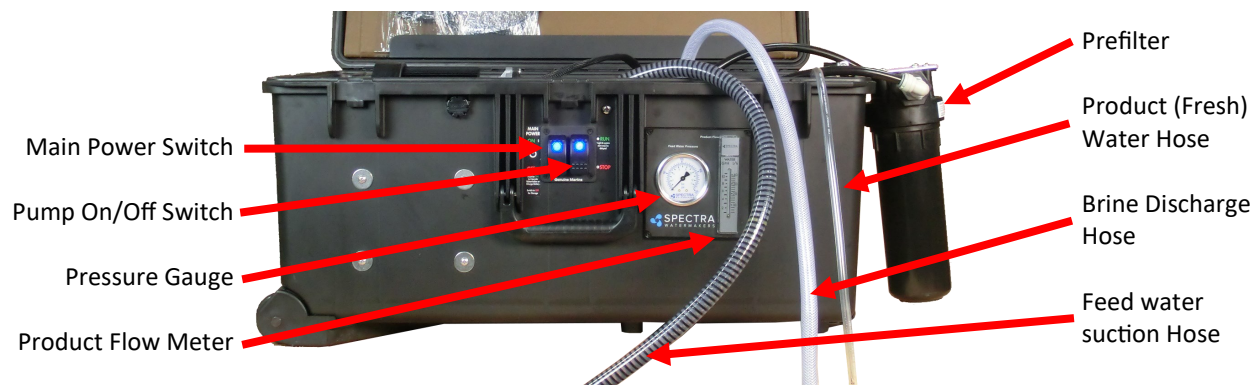

Shutting Down

1. You will need 10 liters (3 gallons) of water in a container, which will be used to flush the watermaker. **Use only unchlorinated water for flushing, product water is ideal.**
2. Place the suction hose in the flush water (see page 9) and start the feed pump.
3. Flush until the container is empty and then stop the feed pump.
4. Disconnect the hoses and connect the short suction hose to the brine discharge so water does not leak into the case. Leave the lid open until the inside of the case is dry.

The system can sit for up to five days without further attention. The system should be flushed after every use. You may notice that the system output is higher while is plugged in to AC power, as the pump will run faster with more power.

Always ensure that the battery is fully charged after the watermaker is shut down to extend battery life.

Maintenance

General

Periodically inspect the entire system for leakage and chafe on the tubing and hoses. Repair any leaks you find as soon as practical. Some crystal formation around the Clark Pump blocks is normal. Wipe down any salt encrusted areas with a damp cloth. If any rust appears at the stainless steel fittings, clean them up promptly. Keep the inside of the case dry and salt free to protect the electrical components inside.

The Seawater Strainer

The sea water strainer's stainless steel element should be inspected, opened, and cleaned as needed. Check frequently during operation.

The Prefilter

Service the prefilter on a regular basis. The pressure will rise on the pressure gauge when the filter becomes dirty. Extremely dirty filters will harm system performance and may cause the feed pump to cycle on the high pressure cut-out switch. Do not leave dirty filters in the machine during long idle periods, as biological contamination will result.

To service the filter, swing it out of the case, open the housing, and discard the old filter. Clean out the housing bowl, reassemble the housing with a new 5 micron filter element. Leave dry until next startup.

Use only Spectra approved filters or you may void your warranty. The filter may be cleaned several times by soaking it in water in a bucket. Occasionally, lightly lube the filter housing O-ring with silicone grease.

The Feed Pump and Clark Pump

The feed water pump and the Clark Pump require no routine maintenance except inspection for leaks. Tighten any hose clamps or fittings that show signs of leakage. The high pressure fittings threaded into the Clark Pump have O-ring seals with a straight thread. These should never leak and should never be over tightened. If one of the tube nuts starts to leak, it can be un-threaded, sealed with a bit of silicone grease or silicone seal, and tightened with two wrenches very tightly.

The Membranes

The membranes need to be cleaned only when feed pressure begins to rise due to fouling or the product quality degrades. The primary causes of fouling are biological growth and scaling. Biological growth occurs when the system is left unused without flushing or pickling. Fouling from mineral scaling will form when the feed water is “hard” or high in carbonates. Very small “colloidal metal” and metal oxide particles can also plug the pores in the membrane. Monitor the product salinity and feed pressure for higher than normal readings for the existing conditions. Other conditions can cause high pressure such as cold feed water or clogged filters. Low product flow is usually due to low voltage, damaged feed pump or Clark Pump. Look for all other causes before cleaning the membrane. Membrane life can be shortened by excessive cleaning.

There are two types of cleaners: acid and alkaline. The acid cleaner (SC-3) will remove mineral scaling. The alkaline cleaner (SC-2) is used to remove biological by-products, oil, and dirt particles that get past the prefilters. If membrane performance is reduced and it has not been “pickled” recently, cleaning with both chemicals is recommended. The acid cleaner should be used first. Colloidal Metals and Metal Oxides are very difficult to remove. If the membrane fails to respond to both cleanings, this is an indication of another problem with the system, or that it is time to replace the membrane. Contact Spectra Watermakers before removing a membrane.

Short Term Storage

Fresh Water Flush

The purpose of the fresh water flush is to replace the sea water in the watermaker with fresh water whenever the system is not operating. The watermaker will last longer and operate better if it is always filled with fresh water between uses. If the watermaker is not used for more than five days it should be flushed again to ensure that the water inside stays fresh and oxygenated. In this way, the water maker can be kept ready for immediate use indefinitely.

1. You will need 10 liters (3 gallons) of water in a container, which will be used to flush the watermaker. **Use only unchlorinated water for flushing, product water is ideal.**
2. Place the suction hose in the flush water (see page 9) and start the feed pump.
3. Flush until the container is empty and then stop the feed pump.
4. Disconnect the hoses and connect the short suction hose to the brine discharge so water does not leak into the case. Leave the lid open until the inside of the case is dry.

If the only fresh water available is chlorinated then a Charcoal (or Carbon) filter is required in the filter housing. Flushing with chlorinated water will damage the membrane.

After five days, if the watermaker has not been used, re-flush following the above procedure.

Remove the hoses, drain them, and stow them away in the case. Insert the hose connection plugs in the hose fittings.

Introduction to Spectra Chemicals

We use four types of chemicals: SC-1, SC-2, SC-3, and propylene glycol antifreeze. SC-1 and propylene glycol are for system storage, while SC-2 and SC-3 are for membrane cleaning.

Note: Never use any chemicals with the system pressurized! Always open the pressure relief valve 1/2 turn. Always follow the instructions for purging the chemicals as shown in the New System Startup section of your owner's manual.

Storage: SC-1 prevents biological growth when your system is idle. It should not be used as a cleaning chemical, nor will it protect your system from freezing. A jar of SC-1 is mixed with 1 to 2 gallons of product or dechlorinated fresh water in a bucket and circulated through the system for 10 minutes. This treatment will protect the system for six months, after which the SC-1 treatment must be repeated. To use SC-1, follow the instructions for **Ventura MPC Storage Procedure** on the following page.

Spectra systems should be stored with propylene glycol if freezing is likely to occur. This is a food grade antifreeze used to winterize RV's, boats, and cabins. Propylene glycol also works very well for preventing biological growth in warm climates and is good for one year. See **Winterizing with Antifreeze** (OP-1 document on the Spectra website).

Note: Do not use metasodium-bisulfate, Citric Acid, or any other storage chemical not supplied by Spectra. These chemicals, used to store other watermaker brands, are very acidic and will damage the Clark Pump and void the warranty.

Cleaners: Cleaning can be detrimental to the membrane and shorten its life. Avoid unnecessary cleaning, and avoid cleaning as a diagnostic tool.

SC-2 is an alkaline cleaner used to remove light oil, grime and biological growth. It is most effective if heated to 120 deg. F, which is difficult on a boat. In most cases the water quality will increase in PPM (salinity) after an SC-2 cleaning. After a few hours it should recover to near the level it produced before the cleaning.

SC-3 is an acid cleaner used to remove mineral and scale deposits. In most cases this is used first and if there is no improvement, go on to the SC-2. SC-3 will in most cases lower the product PPM and overall pressures. Scaling is a slow process that may take several months or years. SC-3 is less harmful to the membrane and will almost always improve the performance of an older membrane.

For cleaning with either SC-2 or SC-3, see the **Cleaning Procedure**.

Long Term Storage Procedures

Watermakers are best run continuously. When not in use, biological growth in the membrane is the leading cause of membrane fouling. A warm environment will cause more growth than a cold environment. If the system is to be left unused for more than five days, perform the following storage procedure. The procedure introduces a chemical compound into the system that prevents biological growth. This procedure requires de-chlorinated water. Spectra SC-1 a special storage compound, formulated to be compatible with the modern engineering plastics and composites in the Spectra pumps. **Do not use any substitute except propylene glycol** (with no Ethyl Alcohol). If you wish to use glycol for storage, follow the winterizing instructions on the container. SC-1 storage compound must be mixed at a ratio of 1 packet to 3 gallons (12L) of fresh water to have the proper solution for up to six months storage.

Caution! Avoid contact with skin, eyes, or lungs with the storage chemical.

Aquifer Storage Procedure

The watermaker can be stored for periods up to six months using this procedure.

1. Make or buy 4 gallons of chlorine-free water and put it in a bucket.
2. Place the end of the feed hose in the bucket and the brine hose to drain.
3. Start and run the feed pump until you have one gallon of fresh water left in the bucket.
4. Mix 1 packet of SC-1 storage compound with the water in the bucket and place the end of the brine service hose in the bucket.
5. **Make sure the pressure relief valve on the Clark Pump is OPEN (unpressurized) by turning $\frac{1}{2}$ turn counterclockwise**
6. Turn on the feed pump. Circulate the storage chemical in the system for approximately 10 minutes. Turn off the feed pump when finished.

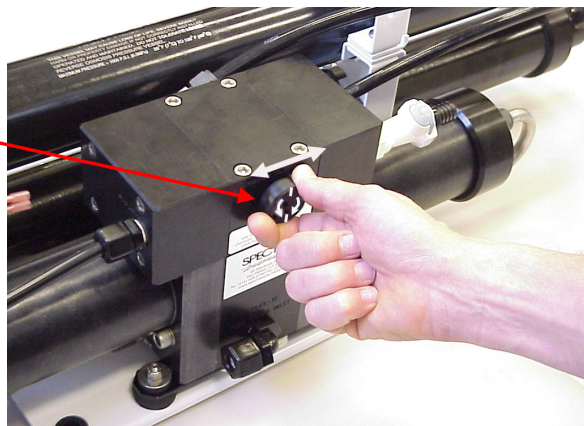

Clean Up

- Remove the 5 micron filter element from its housing and put in a dry one.
- Rinse and dry the inside of the case, being careful not to get water inside the pump motor.
- Charge the battery.
- Remove the hoses, drain them, and stow them away in the case. Insert the hose connection plugs in the hose fittings.

Storage and Winterizing with Antifreeze

The watermaker can be stored for up to one year in any climate using this procedure.

1. Put 3 gallons of chlorine-free fresh water into a bucket. Perform a fresh water flush as described in the normal operation section. Run the feed pump until the bucket is empty.
2. Pour 2 gallons of low temperature **propylene glycol** (with no Ethyl Alcohol) potable water system antifreeze into the bucket.
3. **Make sure the pressure relief valve on the Clark Pump is OPEN (unpressurized) by turning it $\frac{1}{2}$ turn counterclockwise.**
4. Start and run the feed pump until antifreeze begins to come out of the brine discharge hose.
5. Stop the feed pump. Direct the brine output into the bucket.
6. Start the Feed pump and circulate the remaining antifreeze for a few minutes until well mixed.
7. Stop the feed pump and discard any antifreeze remaining in the bucket.
8. Blow out or drain the product tubing, as it will not contain antifreeze.
9. **Leave the pressure relief valve open.**

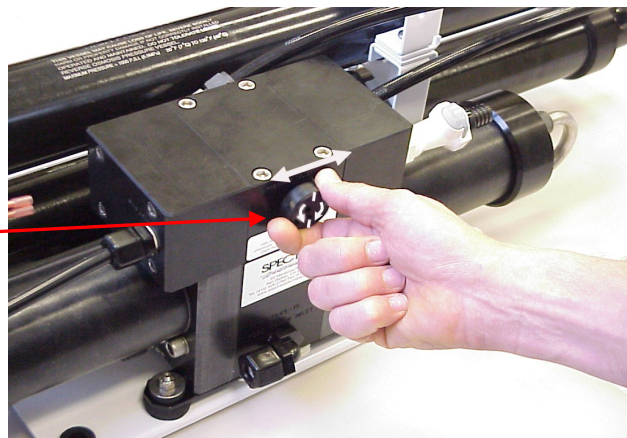

Clean Up

- Remove the prefilter from its housing and replace with a clean dry filter element.
- Rinse and dry the inside of the Aquifer case to prevent corrosion. Do not get the Feed pump motor wet.
- Remove and drain the service hoses and stow them away in the case. Insert the hose connection plugs in the hose fittings.
- Charge or remove the battery for storage.

Recommissioning

Propylene glycol can be difficult to flush from a membrane, especially after extended storage periods. This results in high salinity water (high PPM) and residual flavor in the product water. We recommend flushing the system **WITH THE PRESSURE RELIEF VALVE OPEN** for 4-6 hours after storage with propylene glycol—the longer the better. If, after extended flushing, you still experience low product water quality, cleaning with SC-2 usually removes all traces of propylene glycol and returns the salinity to the level it was before storage with propylene glycol. See the **Cleaning Procedure** on page 20.

Membrane Cleaning

Membrane Cleaning

For normal cleaning, the SC-3 Acid Cleaning Compound is used first, then the SC-2 Alkaline Cleaning Compound. If known bio-fouling is present, the SC-2 may be used first. Using hot water if possible, up to 120° (45C) is recommended, as it greatly enhances the ability of the cleaners to do their jobs.

If the history of the system is unknown or it has been left “unpickled” for an extended length of time and biological growth is present, it is recommended that the system is cleaned with SC-2, using unchlorinated fresh water before the system is run under pressure. If the housing is full of smelly discolored water, the system was not properly stored. Install a clean filter. Check the membrane by running the system for a few minutes in a bucket (see pg.8) and then examine the brine water: if it’s discolored and smells bad, perform an SC-2 cleaning. If the brine is fairly clean, the system can be purged, run normally, and checked for performance. Clean the membranes only if indicated.

Heating the water is preferable. One way to do this is to find a camp stove and use a large stainless steel pot to heat the solution in. The cleaning solution throughout the system will heat as it circulates in and out of the pot. An alternative is to heat the one or two gallons of initial water to 120° on a stove before mixing in the cleaner and circulating it into the system. Periodically stop and reheat the solution.

Spectra cleaning compound (SC-2 or SC-3) must be mixed with fresh water at a ratio of 1 container of compound to 3 gallons (12L) of unchlorinated water. When this concentrate is circulated through the system the chemicals will mix with the water in the system and get to the correct ratio of 8 oz. (250g packet) to 5 gallons (20 liters) of water.

The cleaning procedures are the same for the SC-2 and SC-3 cleaners;

1. Flush the system as shown in the Normal Operation Section and make cleaning solution as above.
2. Place the inlet service hose, brine discharge service hose, and product hose in the bucket.
3. **Make sure that the pressure relief valve is OPEN** (un-pressurized).
4. Mix the cleaning chemical in the bucket.
5. Start the system and circulate the chemical through the system for 20 minutes.
6. Allow the system to soak for an hour; or overnight if the chemicals are cold.
7. Run the pump for another 20 minutes.
8. Stop the pump, move the brine discharge hose to a drain and start the pump until the bucket is empty.
9. Flush the system using the instructions for “New System Startup.”

Suggested Spares

Short term use, weekends etc.

We suggest a basic cruise kit A. This kit consists of six 5 micron filters, and 2 SC-1 storage chemicals.

Use for 2 to 6 months at a time.

Two basic cruise kits, one replacement feed pump head.

Longer than 6 months

Additional filters, Offshore Cruising Kit consisting of Clark Pump seals, O-rings, tools and membrane cleaning chemicals. One replacement strainer.

	Part Number
Spectra Watermakers parts list:	
SC-1 STORAGE CHEMICAL	KIT-CHEM-SC1
SC-2 CLEANER	KIT-CHEM-SC2
SC-3 CLEANER	KIT-CHEM-SC3
BASIC CRUISE A	KIT-BCK-A
5 MIC FILTER	FT-FTC-5
CHARCOAL FILTER	FT-FTC-CC
FEED PUMP HEAD	PL-PMP-SFPH
FILTER HOUSING O-RING	SO-FHS-10H
OFF SHORE KIT	KIT-OFFSH
20" MEMBRANE	FT-MB-20
SUCTION STRAINER	KIT-AQ-ATNASSEM

Troubleshooting

Symptom	Cause	Remedy
----------------	--------------	---------------

Feed pump runs but no pressure	Feed pump air locked Pressure relief valve open	Open pressure relief valve, run until there are no bubbles in the line and then close valve Close valve
No lights on the switches	Battery fuse blown Battery dead	Replace fuse Be sure battery is charged before storage Be sure lights are off on switches when storing
Pump will not run	Main Power switch off Pump Fuse blown	Main Power switch on Replace Fuse
Feed pump starts but shuts down on high pressure	Prefilter clogged Closed valve or blockage in flow	Change filter Check flow path for closed valve or kink in hose
Low water production High feed pressure	Strainer or prefilter clogged	Service prefilter and strainer
Low water production, Low pressure	Pressure relief valve partially open Worn pump head	Close valve Check flow, should be 1.4 GPM Close off discharge hose and pressure should build to 120psi, if not the pump head needs to be replaced
Water production normal, but high feed pressure and/or high amperage	Cold seawater temperature Fouled membrane	Normal condition Clean membrane
Water production normal, but lower pressure, and lower amperage	Warm sea water or brackish water.	Normal condition
Asymmetrical pressure and flow readings between pump shifts	Check valve leaking Failed annular ring Shaft seal leaking	Contact dealer or see the Clark Pump repair manual.



Poor Product Water Quality

With any product water quality issue, you must ensure accurate calibration if you are using a salinity meter. For general quality evaluation, your taste is always good enough.

Membranes are not an exact science and two identical systems can have different product quality. World health standards deem water of up to 1000 PPM of total dissolved solids acceptable for drinking consumption. We consider anything below 750 PPM acceptable but not ideal, and anything below 500 PPM excellent. Factors that could affect water quality are addressed below.

LOW SYSTEM FLOW OR PRESSURE will equate to lower product quality (higher PPM).

Aquifer systems, which have a higher feed to output pressure ratio (See nominal pressures under Flow Test), as well as a higher feed flow/membrane area ratio, will produce water in the 150-200 PPM range.

DAMAGE TO THE MEMBRANE by chlorine contamination. Flushing the system with chlorinated water will irreparably damage the membrane. Charcoal filters are used to absorb any chlorine which might be present in flush water. They must be of proper specification to be suitable. There is no test for chlorine damage except the process of elimination of other causes.

DIRTY OR SCALED membranes. A dirty (foreign material), scaled (mineral deposits), or contaminated (bacterial growth) membrane can result in poor water quality and abnormal operating pressures. If operating pressures are above normal, then cleaning is indicated. If the system pressures are within operating normal range, cleaning may have little result. Avoid cleaning as a diagnostic tool. Low water quality after storage with propylene glycol can usually be remedied by extended flushing or an SC-2 cleaning.

MECHANICAL LEAKAGE within the membrane pressure vessel. This is an unlikely but possible cause of poor water quality with old style Codeline pressure vessels (white). The Spectra pressure vessel has a double O-ring arrangement that includes a telltale hole between them so that any salt water leaking past an O-ring will drip into the case and not go into the product water.

If system flow (product plus brine) is 1.5 GPM or above, the membrane is clean, the product flows are consistent with the system flow and the water quality is still not acceptable, then replacement of the membrane is indicated.



Aquifer Flow Test

The flow test is the most useful diagnostic test for system performance, and should be done before replacing or cleaning your membrane. Changes in production or water quality are normally caused by something **other than** the membrane, unless the system has been left unused for a long time.

Before the flow test, change the filter and clean the sea strainer. Carefully check for water or air leaks, as air in the system will cause low production and erratic salinity. Look for air bubbles in the product flow meter, feed water hoses, and brine overboard hose.

Run the system and watch the pressures very closely. If the feed pressure to the Clark Pump is asymmetrical from one stroke to another, this could be part of the problem. A difference of a few PSI is acceptable, but anything over that is an issue. If the pump is asymmetrical, Clark Pump repairs should be done before continuing with these tests.

If no asymmetry is noted, continue with this test.

Make sure the ShurFlo overpressure cutout switch (PL-PMP-SFPH) is set to 125 PSI. With the pump running, close the brine service valve. The feed pressure should rise to 125 PSI, then the pump should shut off. If the pump shuts off at a lower pressure see "[SF-2 Adjust ShurFlo Pressure Switch](#)," later in this manual.

You will need a graduated bucket and a stopwatch. Measurements must be very accurate, as errors of just a few percent will skew the results. Log the voltage at the feed pump at the same time. Confirm at least 12.5 volts at the pump on 12-volt systems.

1. First divert the product flow into the bucket and record how long it takes to accumulate a given amount. Product flow is usually expressed in Gallons Per Hour or Liters Per Hour, so it's easiest and most accurate to collect the flow for exactly ten minutes, then multiply the quantity by six to get GPH or LPH. Alternatively, you can collect exactly one gallon or four liters then calculate GPH or LPH as follows:

$3600/\text{time in seconds} \times \text{quantity of water} = \text{GPH or LPH}$

There are 3600 seconds in an hour.

Example: It took 9 minutes, 45 seconds to collect 1 gallon of product water, so

$3600/585 \times 1 = 6.15 \text{ GPM}$ (9 times 60 seconds is 540 plus 45 equals 585 seconds).

2. Divert the brine discharge, and the product water, both into the bucket. Feed flow (brine discharge and product combined) is usually expressed in Gallons Per Minute or Liters Per Minute. For the simplest and most accurate measurement, divert exactly 5 gallons or 20 liters, record the time, and calculate GPM or LPM as follows:

$$60/\text{time in seconds} \times \text{quantity of water} = \text{GPM or LPM}$$

Example: It took 3 minutes (180 seconds) to collect 5 gallons of feed flow, so $60/180 \times 5 = 1.67 \text{ GPM}$

System	Feed		Static *	Feed Flow				Product Flow			
	Pressure			Pressure	Flow		MIN	MIN	Flow	Flow	MIN
	psi	bar	psi	gpm	lpm	gpm	lpm	gph	lph	gph	lph
Aquifer 150	60-70	4.2-5	10-15	1.7	6.4	1.65	6.2	6.5	24.6	5.7	21.5
Aquifer 200	80-90	5.6-6.3	20-25	1.7	6.4	1.6	6.0	8.3	31.4	7.7	29.1

*pressure relief valve open ½ turn

In order to make good water, you need the proper amount of feed water flow, as in the table above. Compare the product flow to the total feed flow. Product flow should be 7% of total flow for an Aquifer 200, and 9.5% of total flow for an Aquifer 150. If product percentage is low, you may have an internal leak in the Clark Pump.

For every $1/10^{\text{th}}$ of a GPM feed water flow loss, we will lose about $1/2$ gallon per hour of product flow and the salinity will go up 100 PPM.

Low feed flow combined with low system pressures is most frequently due to a worn ShurFlo pump head (PL-PMP-SFPH).

5/23/14



Technical Bulletins

The following pages include Spectra's most commonly used technical bulletins, covering tests, adjustments, troubleshooting, and common points of confusion.

MISC-1: DWYER FLOW METER SERVICE

The mechanical flow meter, PL-FMT-10 (10 GPH range) or PL-FMT-20 (20 GPH range) can be opened for cleaning if it becomes difficult to read or if the little ball gets stuck.

The flow meter will come completely apart for cleaning. First remove the meter from the panel. Remove the four small screws that hold the stainless steel bracket in place. Carefully pry off the bracket. On the very top of the meter is a clear plastic slide-off cover over an Allen screw. Use a flat bladed screwdriver to push the cover off. Holding the meter upright, remove the Allen screw with a ¼" Allen wrench. Invert the flow meter and catch the ball as it falls out. You can use tooth paste or plastic window polish to polish the inside using a small bottle brush. Clean the ball and give it a few coats of wax. If the o-rings are damaged or the unit has been leaking, install new o-rings using a little silicone grease to ease assembly. These are standard o-rings and should be available at most larger auto parts or bearing stores. Reassemble in reverse.

MISC-3 ACCUMULATOR PRESSURE

Your Spectra Watermakers is supplied with a pressure accumulator tank (PL-ACC-TK), which should be installed in the feed water line between the prefilters and the Clark Pump.

The purpose of the feed line accumulator is to reduce the spikes in the feed pressure caused by the cycling of the Clark Pump. If the accumulator is not properly charged it can lead to problems with the ShurFlo Pump pressure cutout switches. The accumulators have an air valve on top similar to those found on car tires. This allows the internal air bladder of the accumulator to be pre-charged. The accumulator should be pumped up to about 65 psi (4.5 bar) for best results. Add air using a tire pump or air compressor. You can experiment with the exact pressure that will give the best pulsation dampening on your installation.



PF-3 PREFILTERS– ShurFlo

An Aquifer system uses a single 5 micron filter to clean the feed water of abrasive materials while the system is in operation. A carbon filter may be used to prevent the entrance of chlorine during fresh water flushing.

During normal operation, the feed water is filtered in two stages. First it passes through a fine mesh metal sea strainer, which protects the Feed Pump from foreign materials and larger sea creatures. After passing through the Feed Pump, the feed water passes the filter housing containing 5 micron element, removing very fine particles that could damage the Clark Pump and shorten membrane life.

Cleaning schedules will vary widely depending on how and where the system is used. If large amounts of feed water are run through the system over a relatively short period of time in biologically fertile near-shore waters, the prefilters will plug up, water production and quality will drop, and the system pressure will change dramatically. If the pressure gauge was installed before the prefilters, as pictured in this manual, the pressure will increase. If the pressure gauge was installed after the prefilters the pressure will drop

When operated for only an hour or two a day in inland or near-shore waters, the trapped plankton will begin to decay in the filters long before the elements plug up. The decaying plankton and bacteria will cause a “rotten egg” smell in the product water. This decay will set in overnight in tropical waters, or after a week or two in higher latitudes. If handled gently and changed regularly before they get too smelly, filters can be cleaned several times. In crystal clear blue water conditions, the filters may need to be cleaned much less frequently.

If a charcoal filter is used for fresh water flushing the system it will not plug up unless you have some incredibly dirty domestic water in your supply tank. About six months after installation the charcoal filter element will lose its effectiveness and must be replaced. This is purely a function of time.



PF-2: CHARCOAL FILTERS

The charcoal filter element (FT-FTC-CC) removes chlorine from the fresh water flush water supply. The RO membrane can only handle small amounts of chlorine without permanent damage. If the fresh water flush water contains chlorine, the membrane will be exposed to it for days and will produce high salinity water.

The charcoal filter we supply removes 99.7% of the chlorine. Beware when buying other charcoal filters. If they don't specify the percentage of chlorine removed, don't use them. Cheap ones may remove only 60% or 70%. Also, there are aftermarket filters which are very close to, but not exactly, the same dimensions that will not seal properly in the housing. If you skimp on the charcoal filter you risk damaging a \$600.00 membrane on the first flush. The other factor is the flow rate that the filter can handle. Because the chlorine is adsorbed by the charcoal, it must remain in contact with the charcoal for a sufficient period of time for all of the chlorine molecules to be captured. The filters we use can handle 1.5 gallons (6 liters) per minute flow, and are good for 3000 gallons (12,000 liters) at 1.5 GPM, or six months, whichever comes first. Regardless of the flow the charcoal loses its effectiveness after six months.

5/23/14



SF-1: SHURFLO PUMP WON'T RUN

If the pump has power to it (the fan runs), but the pump won't run, first check the pressure switch. The pressure switch (EL-FP-PS) is located on the wet end of the pump and has two red wires plugged into it. Jump the two red wires together and see if the pump runs. You can safely run the system with the pressure switch jumped, just keep an eye on the pressure gauge and don't let system pressure exceed 110 PSI. Replace the switch when a spare is available. The pressure switch should never open unless there is a problem with the system or it is incorrectly adjusted. Check the accumulator pressure, the operating feed pressure, and the switch cut-out setting - bulletins: Misc-3, Misc-4, and SF-2.

If the pump will not run with the pressure switch jumped then it is most likely a problem with the brushes or overheat protection switch inside the motor. The motor will come completely apart by removing the two screws on the end of the motor. Remove the rear cover and paper insulator. Pull out the plastic brush holder. The thermal switch is located on one of the brush leads. With an ohmmeter, check for continuity through the switch. If it is open, you can make temporary repairs by wiring around it, being careful that your new wiring doesn't chafe on the moving parts, nor resist the springs that push the brushes on to the commutator. The overheat switch is unlikely to fail unless the motor has overheated and shut down. Consider relocating the pump or improving ventilation if the overheat protection has failed.

If any corrosion is apparent the brushes may be sticking. Once apart clean all the carbon dust from all the parts. Clean the commutator with light sandpaper. Make sure to clean the small grooves on the commutator with a small sharp tool to remove the carbon in between the segments. Adjust the springs on the brush holders so the brushes slide smoothly in and out. If the bearings are rough and binding, remove the rubber dust cover and clean the best you can, grease them, and work them free by hand. Don't service the bearing unless absolutely necessary. Reassemble in reverse order. You can hold the carbon brushes back with papers clips inserted through the slots in the brush holder so they don't hang up on the bearing during assembly. Make sure the corrugated bearing shim doesn't push out, if it does, push it back into place.

This may keep you going until the motor can be replaced.

5/23/14



SF-2: ADJUST SHURFLO PRESSURE SWITCH

The Shurflo feed pumps are equipped with a high pressure cut out switch (EL-FP-PS). This is the small black unit on the end of the wetted end of the pump head (PL-PMP-SFPH) where the two red wires connect. If the pressure switch is not properly adjusted the pump may cut out each time the Clark pump cycles and the feed pressure spikes. When this happens the production will drop and an unusual noise will be heard when operating on two pumps, but the system will function normally during one pump operation on either pump. The points in the switch will fail fairly fast if set too low because of the constant arcing from cutting out each time the Clark pump shifts.

For all systems except the Gulfstream the feed pump pressure switches should be set as follows. On the very center of the switch is a small 5/64" Allen screw. Run the system on pump one and close the brine discharge valve (1/2 way 90 deg), or kink the discharge hose, to block the flow. Watch the pressure gauge and adjust the pressure switch to shut off at 125 psi. Repeat for pump two. Turn the Allen screw clockwise to increase the cut off set point.

Gulfstream models could experience seal failures in the manifold if pressurized too high. For this reason the pump should be removed from the system and the switch adjusted using a separate pressure gauge. If replacing a feed pump or pump head for a Gulfstream model arrange to preset the switch before installation.

5/23/14

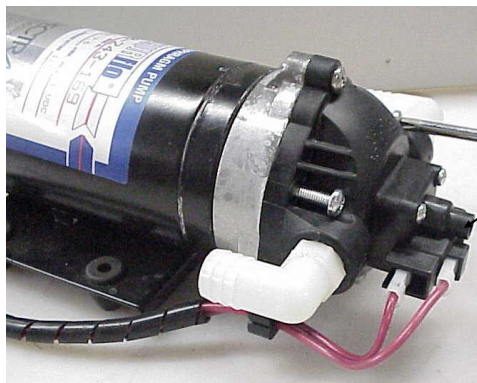

Pressure Switch
Adjusting Screw

Fast & Tite® Thermoplastic Fittings

Fast & Tite® fittings are the most complete line of plastic fittings for thermoplastic tubing in the industry.

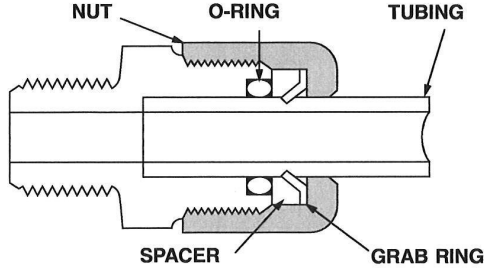

Fast & Tite® thermoplastic tube fittings from Parker will prove to be the answer to your tubing connector needs. Patented Fast & Tite® fittings install in seconds without tools and provide a tight, sure, leak proof seal without clamps or adjustments. A unique 302 stainless steel grab ring for tube retention, coupled with a Nitrile O-Ring for positive seal, assures good tube connection with only hand tight assembly. A plastic grab ring is also available upon special request. Vibration or tube movement will not break the seal and cause leakage. Preassembled in either highly inert polypropylene, or strong, durable nylon, Fast & Tite® fittings are the answer to full flow thermoplastic tubing system requirements. When necessary, Fast & Tite® fittings can be disassembled by hand for fast system drainage. Fittings are completely reusable.

Parts are easily replaced. O-Rings are standard size and universally available. (For applications requiring other than Nitrile O-Rings, consult your Fast & Tite® distributor.)

Use Fast & Tite® fittings with Parker Parflex tubing or other plastic, glass or metal tubing for low pressure or vacuum lines up to the pressure limits shown below.

Fast & Tite® fittings meet FDA and NSF-51 requirements for food contact.

Working Pressures for Fast & Tite® Fittings

Tube O. D., in.	Air-Oil-Water Pressure in PSI		
	Up to 75°F	76° to 125°F	126° to 175°F
1/4	300	300	300
5/16	300	300	300
3/8	250	250	150
1/2	200	200	150
5/8	150	100	50

Ratings are based on use with copper tubing, and in all cases represent the maximum recommended working pressure of the fitting only. Working pressures (vs. temperatures) of other types of tubing may limit the tube and fitting assembly to pressures lower than shown above. Consult factory for recommendations on applications other than shown above.

Temperature Range:

Black/White Polypropylene: 0°F (-18°C) to +212°F (+100°C)
White Nylon: -40°F (-40°C) to +200°F (+93°C)

Fast Assembly

Step 1.

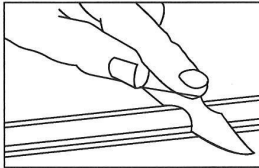

Cut the tube squarely and remove any burrs.

Step 2.

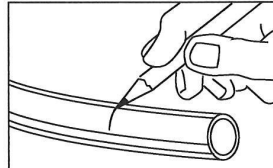

Mark from end of tube the length of insertion. (See table below)

Tube O.D. (in.)	Insertion Length with Tube Support (in.)	Insertion Length without Tube Support (in.)
1/4	5/8	9/16
5/16	5/8	9/16
3/8	13/16	3/4
1/2	7/8	13/16
5/8	1	15/16

Step 3.

Loosen nut on fitting until three threads are visible. Fittings for glass tubes must be disassembled and the grab ring removed.

Step 4.

Moisten end of the tube with water. Push the tube **Straight** into fitting until it bottoms on the fitting's shoulder. Tighten nut by hand. Additional tightening should not be necessary, but 1/4 additional turn may be added if desired. **Do not overtighten** nut as the threads will strip and the fitting will not function properly. A proper assembly will not show the insertion mark extending beyond the nut. If the insertion mark is visible, then steps 1 thru 4 must be repeated.

Step 5.

When using clear vinyl tubing or urethane tubing, it is necessary to use a **TS** tube support. Disassemble the fitting and place the nut, grab ring, spacer and tube support, in that order on the tube. Locate the grab ring at the insertion mark as shown. Seat the O-ring in the body, then proceed with Step 4.

Note: Provide adequate fail-safe mechanisms such as leakage detection sensors, automatic shut-off controls or other industry and code appropriate fail-safe devices in the design of your water-handling appliance to protect against personal injury and property damage.

Plastic fittings containing an o-ring that are used in water applications should be replaced at least every five years or more frequently depending on the environment and severity of the application.

Spectra High Pressure Tube Fitting Assembly Instructions

The Aquifer has eight high pressure fittings, two on each cylinder on the Clark Pump, two on the pressure vessel end caps, and two 90-degree elbows on the back of the Clark Pump. As the compression fitting is tightened, it compresses a ferrule onto the stainless tubing, fixing the ferrule permanently to the tube and holding the compression nut captive.

The body of the fitting seals to the underlying component with an O-ring. On the Clark Pump cylinders and the end caps this O-ring is compressed by tightening the entire fitting. The O-rings on the 90-degree fittings on the back of the Clark Pump have captive nuts and washers, which compress the O-rings without turning the entire fitting.

If a tube fitting leaks it can sometimes be resealed by just tightening. You must use two wrenches, a 13/16-inch wrench to hold the base, and a 7/8-inch wrench to turn the compression nut. The 13/16-inch wrench will need to be thin so as not to interfere with the compression nut. If this doesn't work, disassemble the fitting, grease liberally with silicone grease (the ferrule and the threads) and re-tighten firmly.

The base O-rings should be **gently** compressed to achieve a good seal, and may be damaged by overtightening, the washer or the base of the fitting should just touch the block.

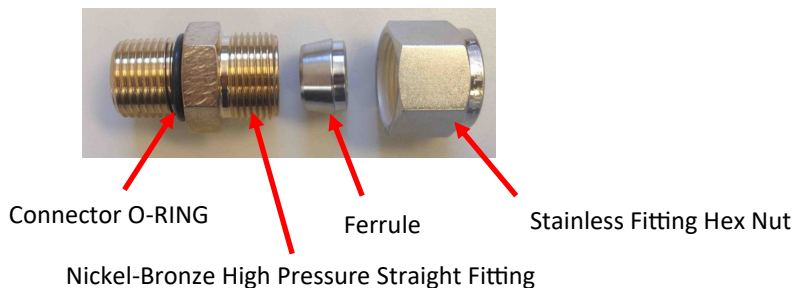

Part Numbers

Front View



CLARK PUMP
KIT-HP-10R

1/2" High Pressure Tube
PL-NLT-1/2HP

STAINLESS STEEL HIGH
PRESSURE ELBOW
PL-MTE-3/4SX1/2

Rear View

Plate Bracket End
FM-PVB-PBE



PRODUCT OUTLET
FITTING
PL-FTE-1/8X1/4P

NIPPLE
PL-NP-1/8N

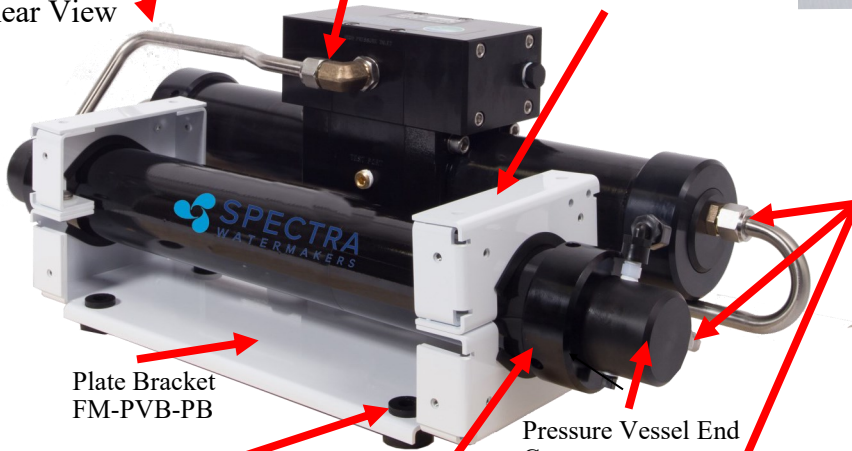

STAINLESS STEEL HIGH
PRESSURE STRAIGHT
FITTING
PL-MTS-3/8X1/2S

3/4"-16 Straight Thread O-RING
SO-FT-STF

Plate Bracket
FM-PVB-PB

Rubber Mount
HD-RBP-RM
Plastic Spacer
HD-SPN-MKINS

Pressure Vessel End
Cap
FT-PV-EP

Pressure Vessel End Ring
FT-PV-ER

1/2" Stainless Ferrule
PL-HWR-1/2FR

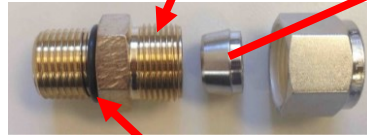

Connector O-RING
SO-HPP-CT

Stainless Fitting Hex Nut
PL-HWR-1/2HN

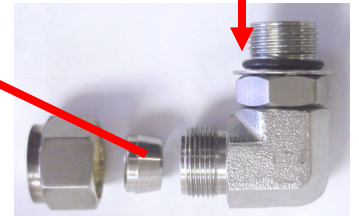

Part Numbers

Complete Feed Pump 12Volt, EL-FP-12V, (24Volt) EL-FP-24V

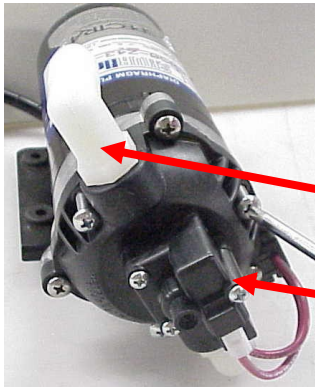

Pump Head Assembly W/Press. Switch
PL-PMP-SFPH

3/8"NPT X 5/8" Hose Barb
Elbow PL-HBE-3/8X5/8

Feed Pump Pressure Switch
EL-FP-PS

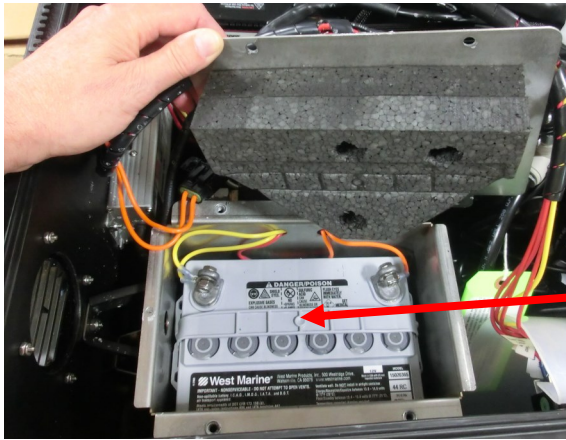
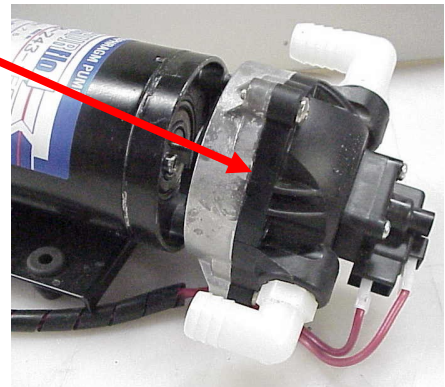

EL-BAT-AQB
AQUIFER BATTERY

EL-PS-24V240W67
AQUIFER AC POWER
SUPPLY

FT-PV-ER
Pressure Vessel End Ring



FT-PV-EPI
MEMBRANE
END CAP

FT-PV-20
20" HIGH PRESSURE
VESSEL

PL-HP-1/8
1/8" HEX PLUG NYLON

PL-MTS-3/8X1/2B
3/8"NPT X 1/2" TUBE FIT-
TING ST. SS.

Part Numbers

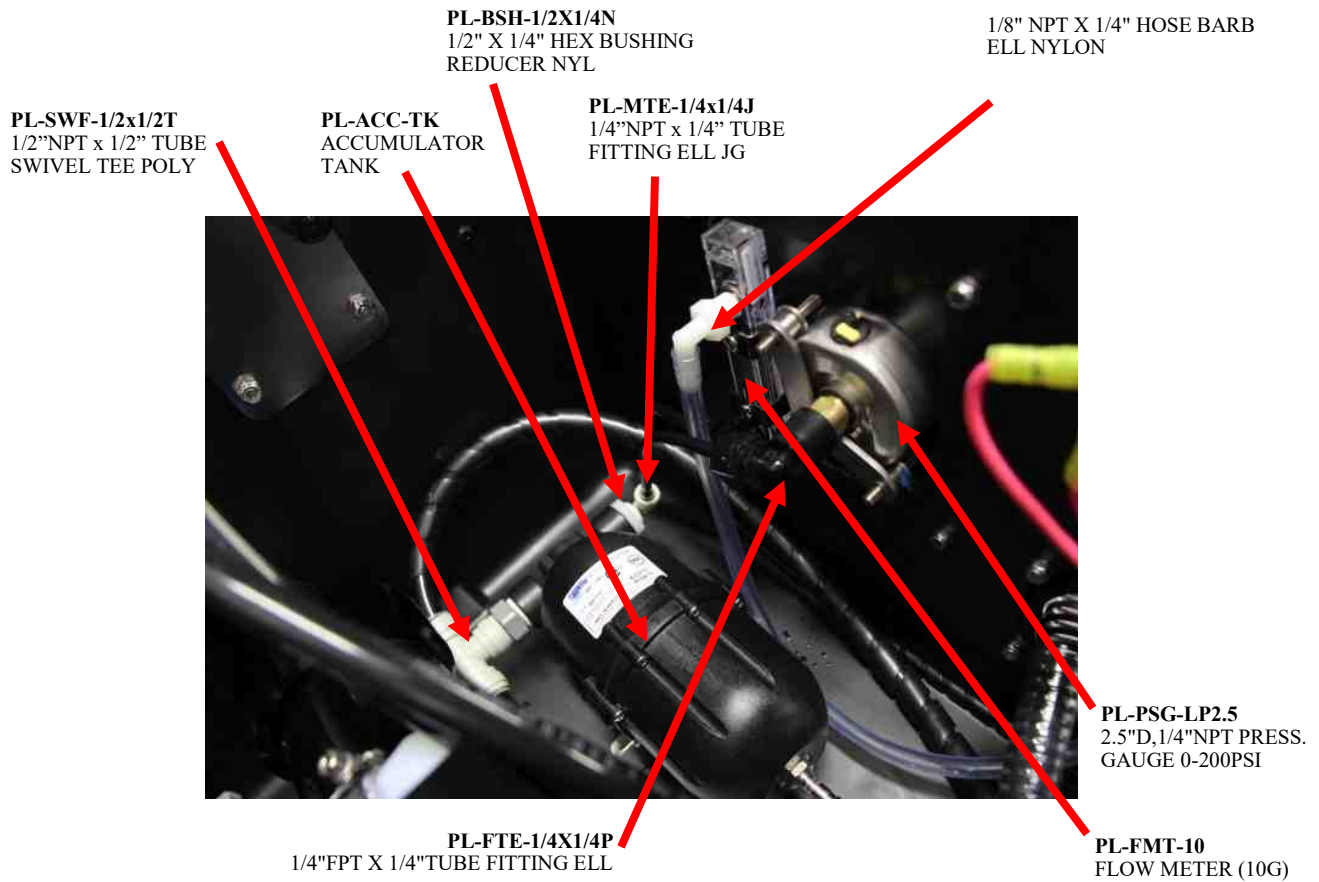
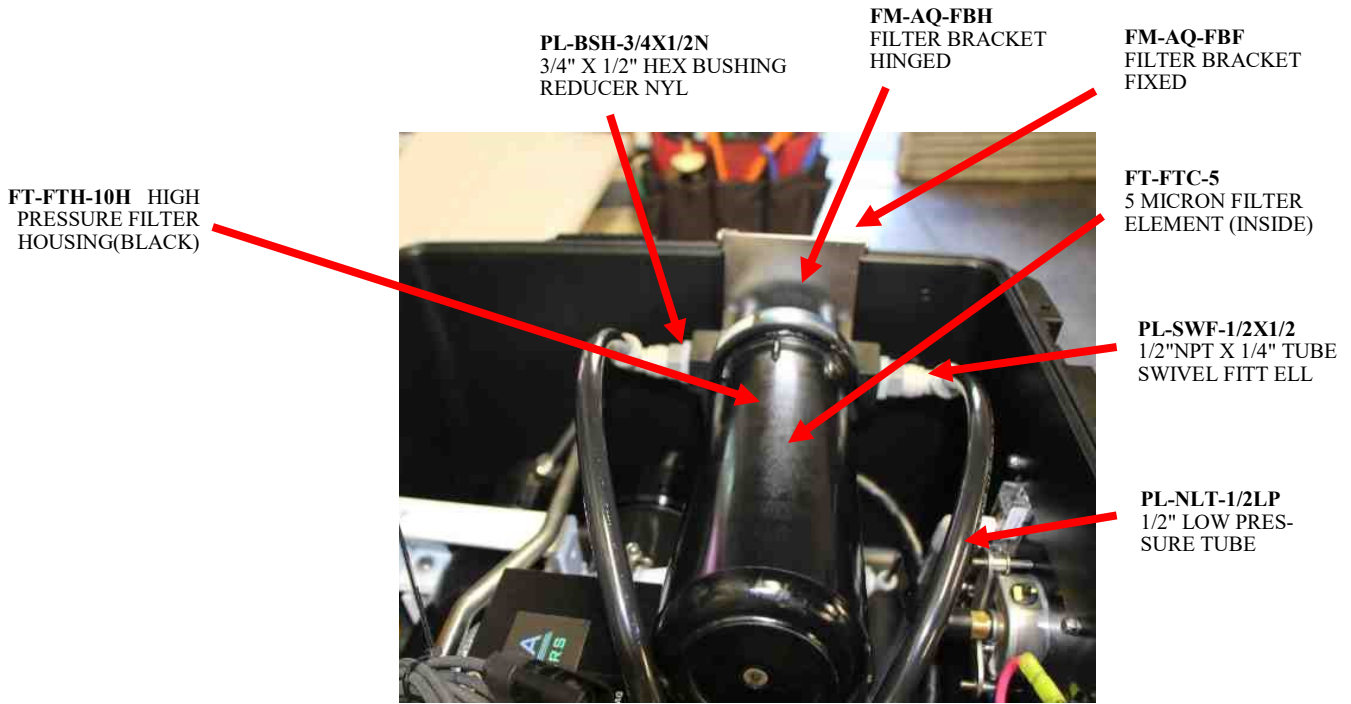

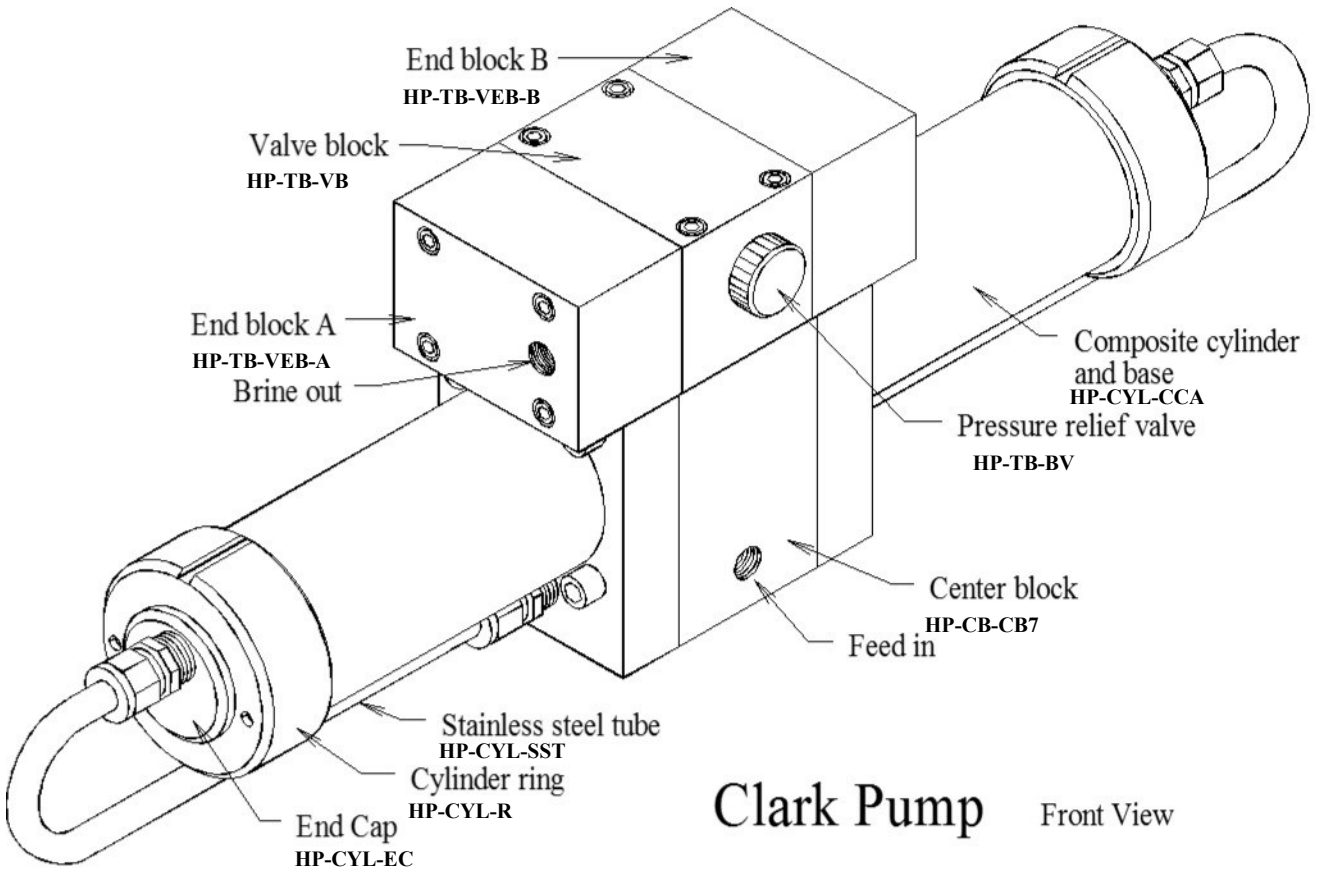

Clark Pump Front View

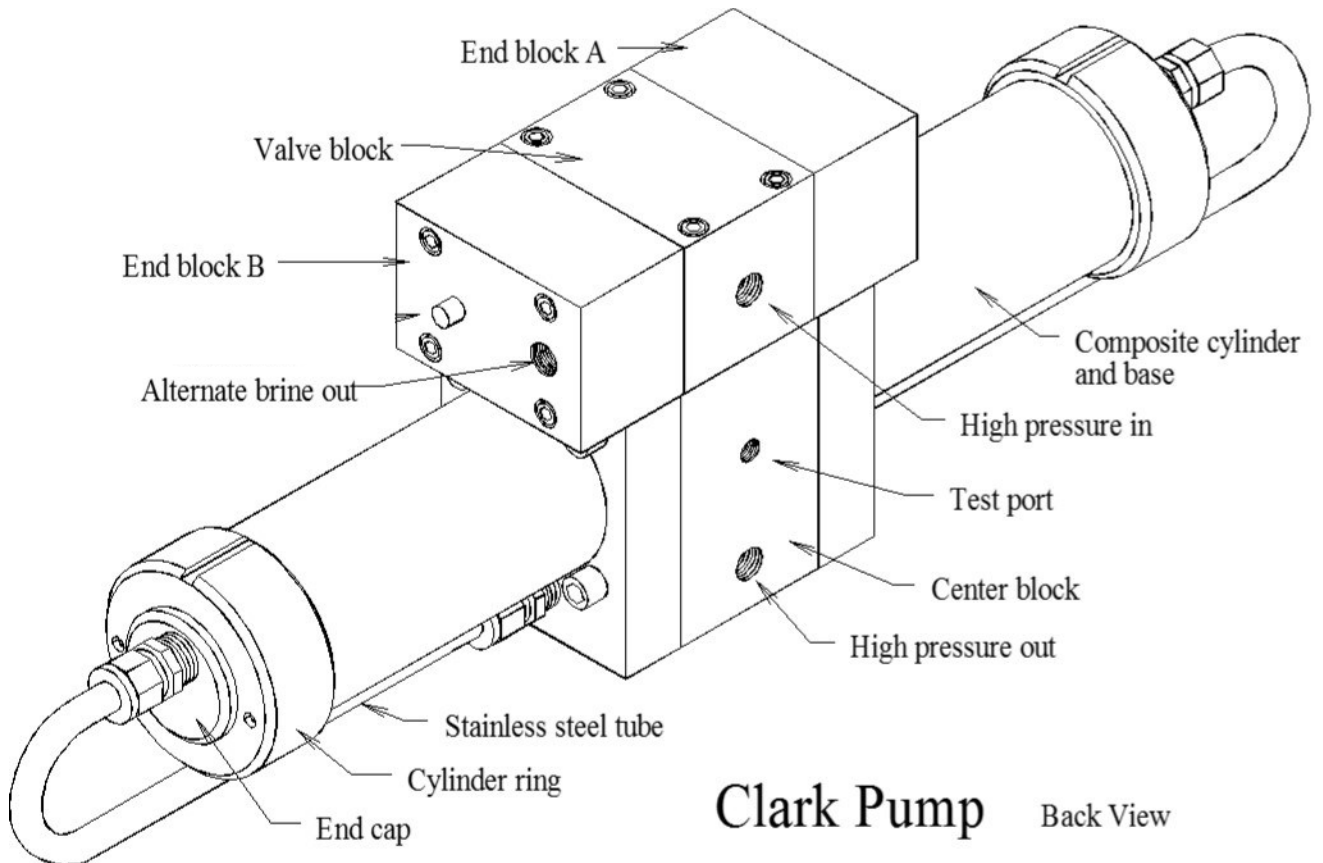

Clark Pump Back View

Spool Assembly
Exploded View

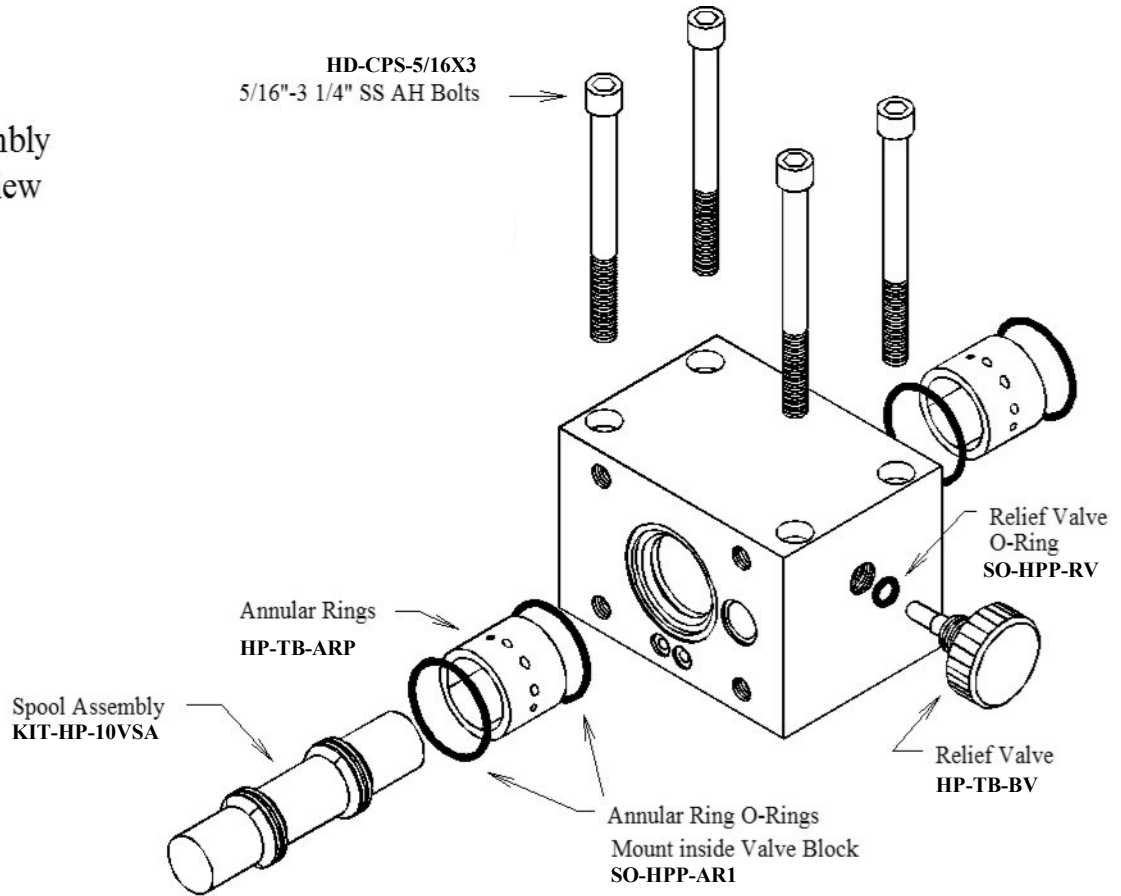

Valve Block

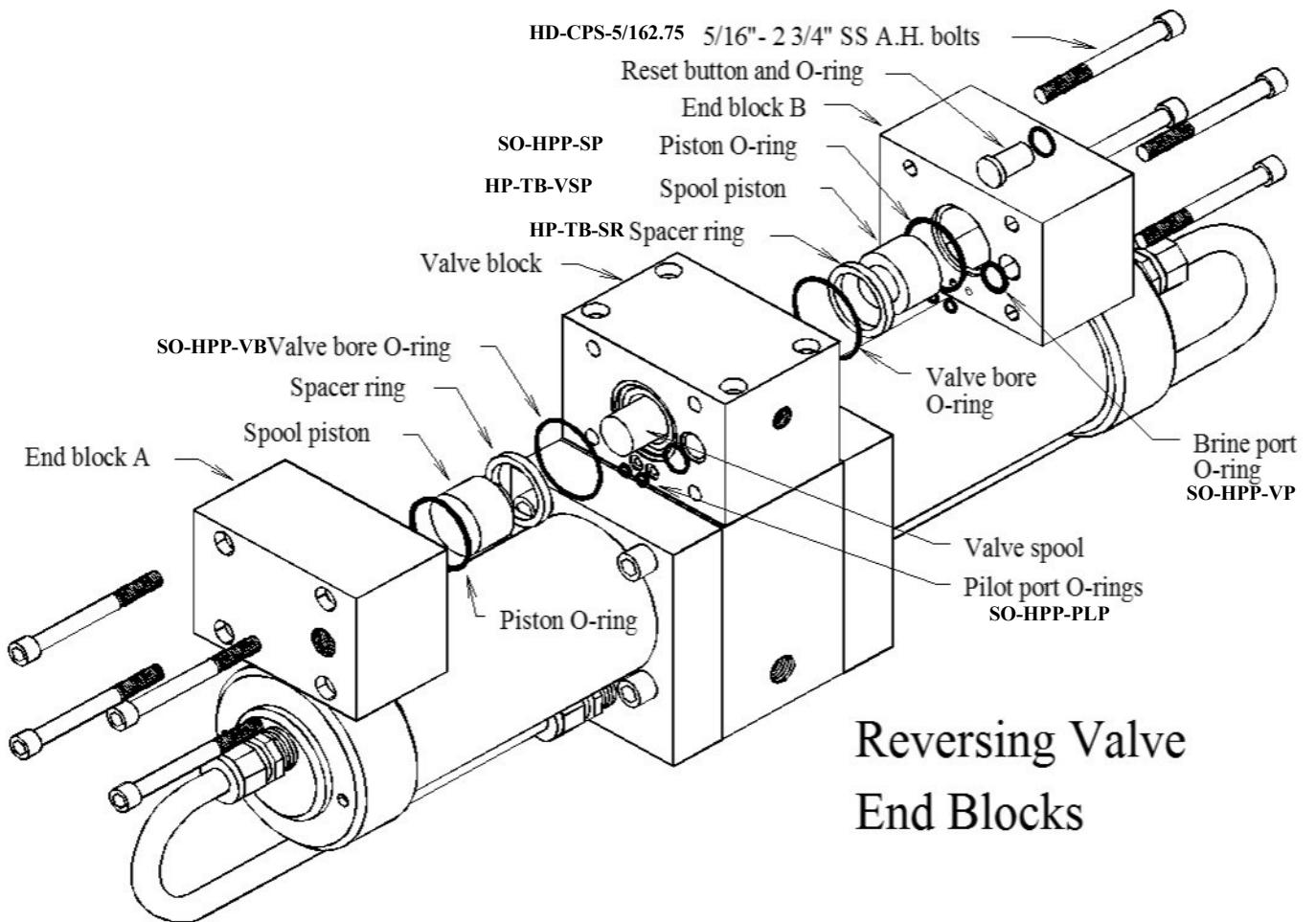

Reversing Valve
End Blocks

Parts

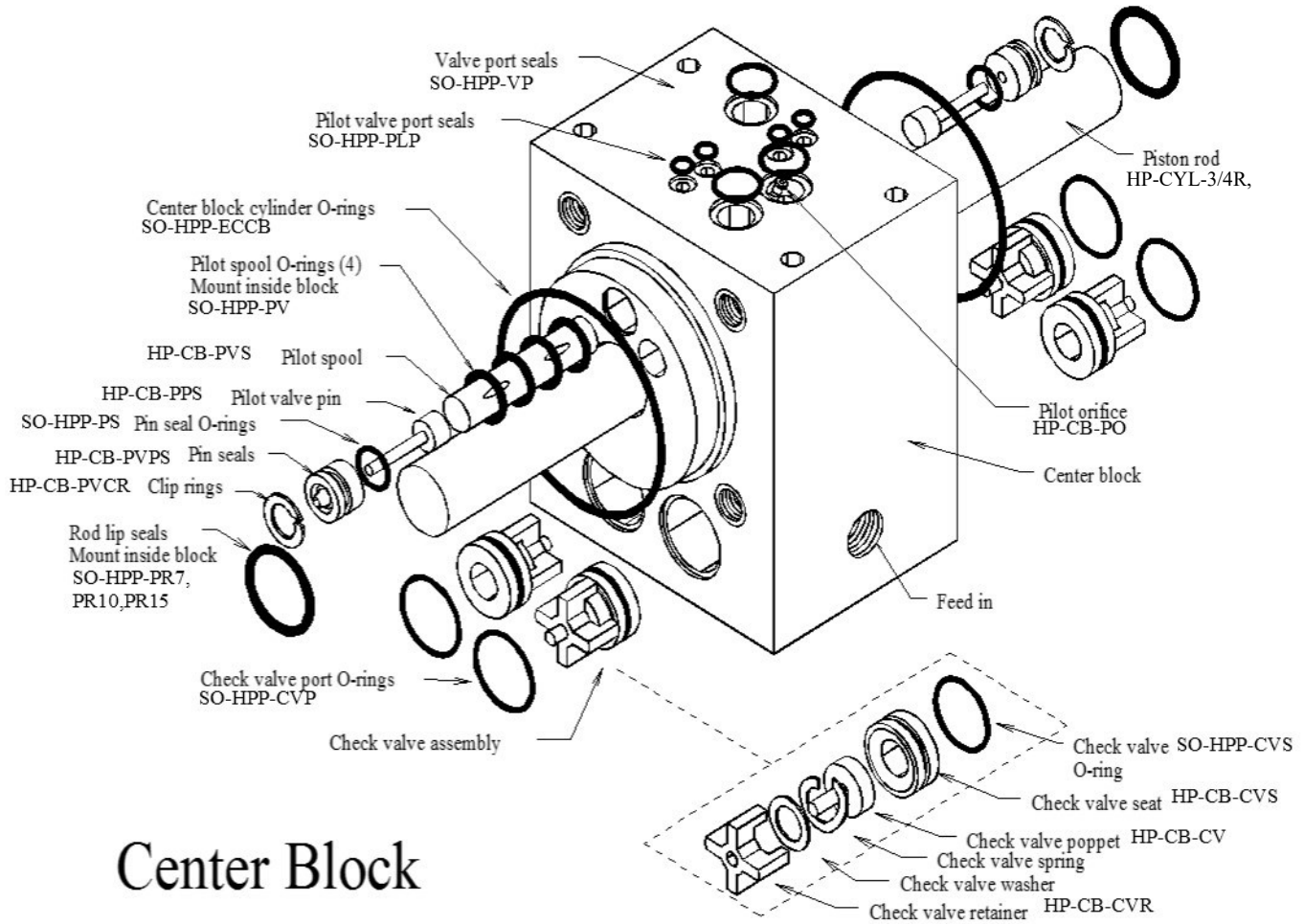

Center Block

Parts

